

*Projector*

# ***P506QL***

---

*User's Manual*

Please visit our web site for User's Manual in the latest version.  
[http://www.nec-display.com/dl/en/pj\\_manual/lineup.html](http://www.nec-display.com/dl/en/pj_manual/lineup.html)

Model No. NP-P506QL
------------------------

# Table of Contents

---

Important Information .....	iii
1 Getting Started .....	1
1-1 Packing Checklist .....	1
1-2 Views of Projector Parts .....	2
Front-right View .....	2
Top view.....	3
Rear view-On-screen Display (OSD) buttons.....	4
Rear view (Terminal Panel).....	5
Bottom view .....	6
Reference drawings for stand.....	7
1-3 Remote Control Specification .....	8
1-4 Remote Control Operating Range .....	10
1-5 Projector and Remote Control Buttons .....	10
2 Setup and Operation .....	11
2-1 Inserting the Remote Control Batteries.....	11
2-2 Starting and Shutting down the Projector .....	12
2-3 Adjusting the Projector Level .....	14
2-4 Adjusting Projected Image Position Using Lens Shift .....	15
Adjusting the vertical image position .....	16
Adjusting the horizontal image position.....	16
2-5 Adjusting the Zoom, Focus and Keystone .....	17
2-6 Adjusting the Volume.....	18
3 On-Screen Display (OSD) Menu Settings .....	19
3-1 OSD Menu Controls.....	19
Navigating the OSD.....	19
3-2 Setting the OSD Language.....	20
3-3 OSD Menu Overview .....	21
3-4 INPUT Menu.....	23
COMPUTER Menu.....	24
3D Setting .....	25
3-5 ADJUST Menu .....	26
DETAIL SETTINGS Menu .....	27
WHITE BALANCE .....	28
ADVANCED Feature.....	29
COLOR CORRECTION .....	30
3-6 DISPLAY Menu .....	31
3-7 NETWORK Menu .....	32
LAN_RJ45 .....	33
Wired LAN Terminal functionalites .....	33
Supported External Devices .....	33
LAN_RJ45 .....	34
3-8 SETUP.....	39
LIGHT MODE .....	40
STANDBY MODE.....	41
MENU .....	42
SECURITY.....	43
3-9 INFO. Menu.....	44

---

4	Maintenance and Security.....	<b>45</b>
4-1	Cleaning the Projector.....	45
	Cleaning the Lens.....	45
	Cleaning the Case.....	45
4-2	Using the Physical Lock.....	46
	Using the Security Slot.....	46
	Using the Security Bar Lock.....	46
5	Troubleshooting.....	<b>47</b>
5-1	Common Problems and Solutions.....	47
5-2	Tips for Troubleshooting.....	47
5-3	LED Error Messages.....	48
5-4	Image Problems.....	48
5-5	Light Source Problems.....	49
5-6	Remote Control Problems.....	49
5-7	Audio Problems.....	49
5-8	Having the Projector Serviced.....	49
5-9	HDMI Q & A.....	50
6	Specifications.....	<b>51</b>
6-1	Specifications.....	51
6-2	Projection Distance vs. Projection Size.....	53
	Projection Distance and Size Table.....	54
6-3	Timing Mode Table.....	55
	Table of Supported Frequency.....	55
	Table of Supported Frequency For 3D mode.....	57
6-4	Projector Dimensions.....	58
7	Appendix I.....	<b>59</b>
7-1	RS-232C Protocol.....	59
	REGISTER YOUR PROJECTOR! (for residents in the United States, Canada, and Mexico).....	60

## Important Information

---

# Important Information

### Important Safety Information





*It is strongly recommended that you read this section carefully before using the projector. These safety and usage instructions will ensure that you enjoy many years of safe use of the projector. Keep this manual for future reference.*









### About the Symbols

To ensure safe and proper use of the product, this manual uses a number of symbols to prevent injury to you and others as well as damage to property.

The symbols and their meanings are described below. Be sure to understand them thoroughly before reading this manual.

 <b>WARNING</b>	Failing to heed this symbol and handling the product erroneously could result in accidents leading to death or major injury.
 <b>CAUTION</b>	Failing to heed this symbol and handling the product erroneously could result in personal injury or damage to surrounding property.

### Examples of Symbols

	This symbol indicates you should be careful of electric shocks.
	This symbol indicates you should be careful of high temperatures.
	This symbol indicates something that must be prohibited.
	This symbol indicates something that must not be got wet.
	This symbol indicates you should not touch with wet hands.
	This symbol indicates something that must not be disassembled.
	This symbol indicates things you must do.
	This symbol indicates that the power cord should be unplugged from the power outlet.

Safety Caution

 **WARNING**



**BE SURE TO DO**

Handling the power cord

- Please use the power cord supplied with this projector. If the supplied power cord **does not satisfy requirements of your country's safety standard, and voltage and current** for your region, make sure to use the power cord that conforms to and satisfies them.

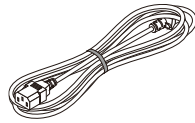

- The power cord you use must be approved by and comply with the safety standards of your country.

Rated voltage by country is listed below for your reference. For selecting an appropriate power cord, please check rated voltage for your region by yourself.

AC 230 V	European countries
AC 120 V	North America



**PROHIBITION**

- The power cord included with this projector is exclusively for use with this projector. For safety, do not use it with other devices.













**HAZARDOUS VOLTAGE**



- Handle the power cord with care. Damaging the cord could lead to fire or electric shock.
  - Do not place heavy objects on the cord.
  - Do not place the cord under the projector.
  - Do not cover the cord with a rug, etc.
  - Do not scratch or modify the cord.
  - Do not bend, twist or pull the cord with excessive force.
  - Do not apply heat to the cord.

Should the cord be damaged (exposed core wires, broken wires, etc.), ask your dealer to replace it.

- Do not touch the power plug should you hear thunder. Doing so could result in electric shock.

 <p><b>BE SURE TO DO</b></p>  <p><b>PROHIBITION</b></p>  <p><b>DO NOT WET</b></p>  <p><b>UNPLUG THE POWER CORD</b></p>	<p>Installing the Projector</p> <ul style="list-style-type: none"> <li>- This projector is designed to be used with a 100–240 V AC, 50/60 Hz power supply. Before using the projector, check that the power supply to which the projector is to be connected meets these requirements.</li> <li>- Use a <b>power outlet as the projector’s power supply. Do not connect the projector directly to electrical light wiring.</b> Doing so is dangerous.</li> <li>- Do not use in places such as those described below. Doing so could lead to fire or electric shock.             <ul style="list-style-type: none"> <li>- Shaky tables, inclined surfaces or other unstable places</li> <li>- Near heating appliances or places with heavy vibrations</li> <li>- Outdoors or humid or dusty places</li> <li>- Places exposed to soot or steam</li> <li>- Near cooking appliances, humidifiers, etc.</li> </ul> </li> <li>- Do not use in places such as those described below where the projector could get wet. Doing so could lead to fire or electric shock.             <ul style="list-style-type: none"> <li>- Do not use in the rain or snow, on a seashore or waterfront, etc.</li> <li>- Do not use in a bathroom or shower room.</li> <li>- Do not place vases or potted plants on the projector.</li> <li>- Do not place cups, cosmetics or medicines on the projector.</li> </ul> <p>Should water, etc. get inside the projector, first turn off the <b>projector’s</b> power, then unplug the power cord from the power outlet and contact your dealer</p> </li> <li>- Do not insert or drop metal or combustible objects or other foreign materials into the projector from the vents. Doing so could lead to fire or electric shock. Be particularly careful if there are children in the home. Should a foreign object get inside the projector, first turn off the projector’s power, then unplug the power cord from the power outlet and contact your dealer.</li> </ul>
 <p><b>UNPLUG THE POWER CORD</b></p>	<p>Unplug the power cord if the projector malfunctions.</p> <ul style="list-style-type: none"> <li>- Should the projector emit smoke or strange odors or sounds, or if the projector has been dropped or the cabinet broken, turn off the projector’s power, then unplug the power cord from the power outlet. Failure to do so could not only lead to fire or electric shock, visual impairment or burn. it could also result in vision impairment. Contact your dealer for repairs.</li> </ul> <p>Never try to repair the projector on your own. Doing so is dangerous.</p>
 <p><b>DO NOT DISASSEMBLE</b></p>	<p>Do not disassemble the projector.</p> <ul style="list-style-type: none"> <li>- Do not remove or open the projector’s cabinet. Also, do not modify the projector. There are high voltage areas in the projector. Modifying the projector could lead to fire, electric shock, or could lead to visual impairment or burn by cause leakage of laser beams. Have qualified service personnel perform inspection, adjustments and repairs of the interior.</li> </ul>

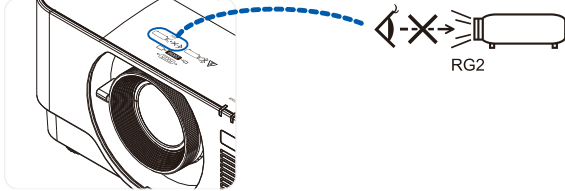





 <p><b>CAUTION</b></p>	<p>Installing suspended from the ceiling</p> <ul style="list-style-type: none"> <li>- Should special works be required, for example to suspend the projector from the ceiling, consult your dealer. Never try to install the projector yourself in such cases. The projector could drop and cause injury. Suspending the projector from the ceiling requires sufficient ceiling strength to support the projector, and the building standards laws in your particular country must be followed. It is also necessary to take measures to prevent the projector from dropping in anticipation of a malfunction occurring in the projector, ceiling mounting device and installation location.</li> <li>- When installed suspended from the ceiling, etc. do not hang from the projector. The projector could drop and cause injury.</li> <li>- When installing suspended from the ceiling, use a power outlet that is within reach so the power cord can be easily plugged and unplugged.</li> </ul>
 <p><b>PROHIBITION</b></p>  <p><b>CAUTION FOR HIGH TEMPERATURE</b></p>	<p>Do not place objects in front of the lens while the projector is operating.</p> <ul style="list-style-type: none"> <li>- Do not leave the lens cap on the lens while the projector is operating. The lens cap could get hot and be warped.</li> <li>- Do not place objects in front of the lens that obstruct the light while the projector is operating. The object could get hot and be broken or catch fire.</li> <li>- The below pictogram indicated on the cabinet means the precaution for avoiding to place objects in front of the projector lens.</li> </ul> 





<p style="text-align: center;">   <b>PROHIBITION</b> </p>	<p><b>About the projector's light source</b></p> <ul style="list-style-type: none"> <li>- Do not look into the projector's lens.</li> <li>- Strong light that could damage your eyes is projected when the projector is operating. Be especially careful when children are around.</li> <li>- Do not look at the projected light using optical devices (magnifying glasses, reflectors, etc.). Doing so could result in vision impairment.</li> <li>- Check that there is no one looking at the lens within the projection range before turning on the projector.</li> <li>- Do not allow children to operate the projector alone. When a child is operating the projector an adult should always be present and watch the child carefully.</li> <li>- The below pictogram, that is indicated near the lens on the cabinet, describes this projector is categorized in the risk group 2 of IEC/EN 62471-5:2015.</li> </ul> <div style="border: 1px solid red; padding: 5px; margin: 10px 0;"> <p>As with any bright light source, do not stare into the beam, RG2 IEC/EN 62471-5:2015.</p> </div> <div style="text-align: center;">  </div>
<p style="text-align: center;">   <b>PROHIBITION</b> </p>	<p><b>When cleaning the projector</b></p> <ul style="list-style-type: none"> <li>- Do not use flammable gas sprays to remove dust from the lens, cabinet, etc. Doing so could lead to fire.</li> </ul>





## CAUTION

 <b>BE SURE TO DO</b>	<p>Connecting the power cord to earth</p> <ul style="list-style-type: none"> <li>- This equipment is designed to be used in the condition of the power cord connected to earth. If the power cord is not connected to the earth, it may cause electric shock. Please make sure the power cord is earthed properly. Do not use a 2-core plug converter adapter.</li> </ul>
 <b>BE SURE TO DO</b>   <b>DO NOT TOUCH WITH WET HANDS</b>   <b>UNPLUG THE POWER CORD</b>	<p>Handling the power cord</p> <ul style="list-style-type: none"> <li>- <b>When connecting the power cord to the projector's AC IN terminal, make sure the connector is fully and firmly inserted.</b> Loose connection of the power cord could lead to fire or electric shock.</li> <li>- Do not connect or disconnect the power cord with wet hands. Doing so could result in electric shock.</li> <li>- When cleaning the projector, for safety purposes unplug the power cord from the power outlet beforehand.</li> <li>- When moving the projector, first be sure to turn off the power, unplug the power cord from the power outlet and check that all connection cables connecting the projector to other devices have been disconnected.</li> <li>- When planning not to use the projector for long periods of time, always unplug the power cord from the power outlet.</li> </ul>
 <b>PROHIBITION</b>	<p>Do not use on networks subject to overvoltage.</p> <ul style="list-style-type: none"> <li>- Connect the projector's Ethernet/HDBaseT port and LAN port to a network for which there is no risk of overvoltage being applied. Overvoltage applied to the Ethernet/HDBaseT or LAN port could result in electric shock.</li> </ul>
 <b>BE SURE TO DO</b>	<p>Lens shift, focus and zoom operations</p> <ul style="list-style-type: none"> <li>- When shifting the lens or adjusting the focus or zoom, do so from either behind or to the side of the projector. If these operations are performed from the front, your eyes could be exposed to strong light and get injured.</li> <li>- Keep your hands away from the lens area when performing the lens shift operation. If not, your fingers could get caught in the gap between the cabinet and the lens.</li> </ul>

 <p><b>PROHIBITION</b></p>	<p>Handling batteries</p> <ul style="list-style-type: none"> <li>- Handle batteries with caution. Failure to do so could lead to fire, injury or contamination of the surroundings. <ul style="list-style-type: none"> <li>- Do not short-circuit or take apart batteries or dispose of them in flames.</li> <li>- Do not use batteries other than those specified.</li> <li>- Do not use new batteries together with old ones.</li> <li>- When inserting batteries, pay attention to the polarities (+ and – directions), and be sure to insert them as indicated.</li> </ul> </li> <li>- Contact your dealer or local authorities when disposing of batteries.</li> </ul>
 <p><b>PROHIBITION</b></p>  <p><b>CAUTION FOR HIGH TEMPERATURE</b></p>	<p>About the vents</p> <ul style="list-style-type: none"> <li>- Do not obstruct the projector’s vents. Also, do not place such soft objects as paper or cloths underneath the projector. Doing so could lead to fire. Leave sufficient space between the place where the projector is installed and its surroundings (as a general rule, at least 50cm/19.69 inches for the intake vent, 50cm/19.69 inches for the exhaust vent).</li> <li>- Do not touch the exhaust vent area while projecting or immediately after projecting images. The exhaust vent area may be hot at this time and touching it could cause burns.</li> </ul>
 <p><b>PROHIBITION</b></p>	<p>Moving the projector</p> <ul style="list-style-type: none"> <li>- When moving the projector, do not hold the lens section. The focus ring could turn, causing the projector to drop and resulting in injury. Also, if you put your hand on the gap between the cabinet and the lens, the projector may be damaged, falling and causing injury.</li> </ul>
 <p><b>BE SURE TO DO</b></p>	<p>Inspecting the projector and cleaning the inside</p> <ul style="list-style-type: none"> <li>- Consult with your dealer about once per year for cleaning of the inside of the projector. Dust could accumulate inside of the projector if it is not cleaned for extended periods of time, leading to fires or malfunction.</li> </ul>

## Laser Safety Caution

Obey the laws and regulations of your country in relation to the installation and management of the device.

For China

This product is classified as Class 3R of GB 7247.1-2012.

 <b>WARNING</b>
<p>CLASS 3R LASER PRODUCT OF GB 7247.1-2012</p> <ul style="list-style-type: none"> <li>• LASER RADIATION - AVOID DIRECT EYE EXPOSURE.</li> <li>• Use of controls or adjustments or performance of procedures other than those specified herein may result in hazardous radiation exposure.</li> </ul>

For other regions

This product is classified as Class 1 of IEC 60825-1 Third edition 2014-05 and RG2 of IEC/EN 62471-5 First edition.

 <b>WARNING</b>
<p>CLASS 1 LASER PRODUCT OF IEC 60825-1 THIRD EDITION</p> <ul style="list-style-type: none"> <li>• Use of controls or adjustments or performance of procedures other than those specified herein may result in hazardous radiation exposure.</li> <li>• Laser energy exposure near aperture may cause burns.</li> </ul>

<p>USA only</p> <ul style="list-style-type: none"> <li>• Complies with 21 CFR 1040.10 and 1040.11 except for conformance as a Risk Group 2 LIP as defined in IEC/EN 62471-5:Ed. 1.0. For more information see Laser Notice No. 57, dated May 8, 2019.</li> </ul>  <b>WARNING</b> <ul style="list-style-type: none"> <li>• Do not allow to look into the projector beam at any distance from the projector. An adult should supervise the children to prevent exposure risks.</li> <li>• Check that there is no one looking at the lens, when using the remote control for starting the projector.</li> <li>• Do not look at the projected light using optical devices(binoculars, telescopes, magnifying glasses, reflectors, etc).</li> <li>• [ WARNING: MOUNT ABOVE THE HEADS OF CHILDREN. ] The use of a ceiling mount is recommended with this product to place it above the eyes of children.</li> </ul>
--

- Outline of laser emitted from the built-in light module:
  - Wave length: 450–460 nm
  - Maximum power: 170 W
- Radiation pattern from the protective housing:
  - Wave length: 450–460 nm
  - Maximum laser radiation output: 32 mW
  - Pulse duration: 1.34 ms
  - Repetition frequency: 120 Hz
- The laser module is equipped in this product. Use of controls or adjustments of procedures other than those specified herein may result in hazardous radiation exposure.

## Light Module

- A light module containing multiple laser diodes is equipped in the product as the light source.
- These laser diodes are sealed in the light module. No maintenance or service is required for the performance of the light module.
- End user is not allowed to replace the light module.
- Contact qualified distributor for light module replacement and further information.

Product labels

The caution and the explanatory labels of the LASER PRODUCT in Class 1 conforming to IEC 60825-1 Third edition, and in CLASS 3R conforming to GB 7247.1-2012 are stuck on the below indicated positions.

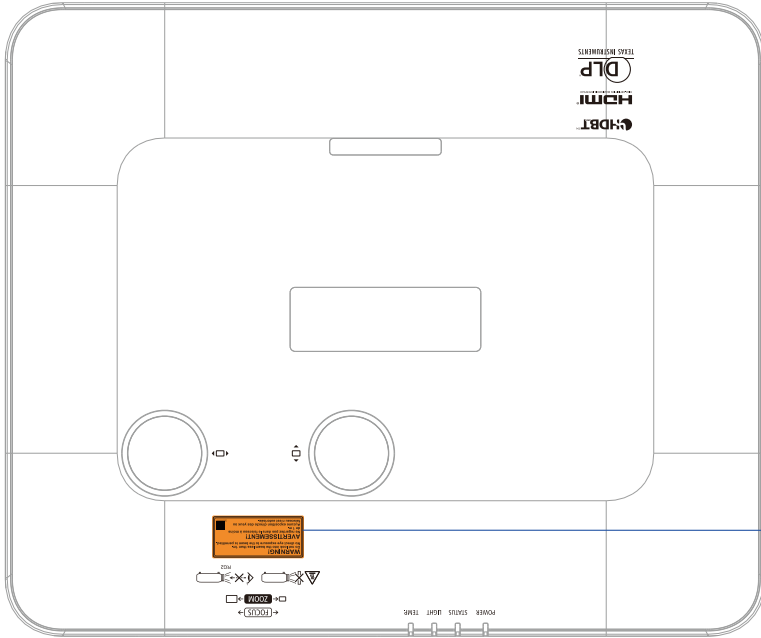

**\*Warning Label Laser**

**WARNING!**  
Do not look into the beam less than 1m.  
No direct eye exposure to the beam is permitted.

**AVERTISSEMENT!**  
Ne regardez pas dans le faisceau à moins de 1 m.  
Aucune exposition directe des yeux au faisceau n'est autorisée.

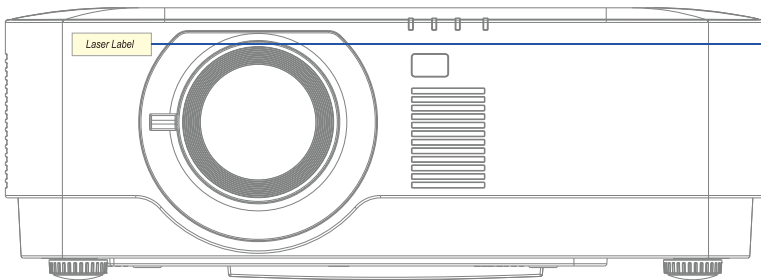

**\*China Model**

激光出口

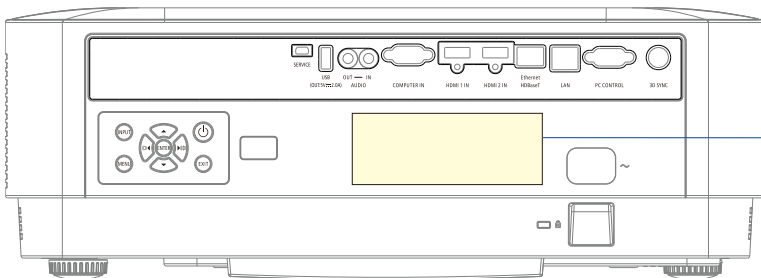

**\*US & EU Model**

CLASS 1 LASER PRODUCT  
LASERPRODUKT DER KLASSE 1  
APPAREIL À LASER DE CLASSE 1  
НАЗЕРНОЕ ИЗДЕЛИЕ 1 КЛАССА ОНАГОРОЧТ  
등급 1 레이저 제품  
第一級雷射產品 クラス1レーザー製品  
IEC/EN 60825-1:2014 JIS C 6802:2014

**\*China Model**

激光辐射  
避免眼睛受到直接照射  
3R类激光产品  
波长: 450-460 nm  
最大脉冲能量: 0.698mJ  
脉冲持续时间: 1.34ms 1类激光产品  
GB 7247.1-2012 IEC 60825-1:2014

*Laser light radiation range*

The figure below shows the maximum radiation range of the laser light. Horizontal angle (unit: degree).

Vertical angle (unit: degree)

Zoom	Lens position		
	Right most	Center (Reference value)	Left most
	HR	HC	HL
Wide	32.3	24.3	32.3
Tele	22.7	16.6	22.7

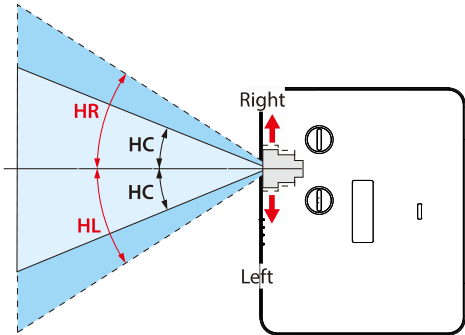

Vertical angle (unit: degree)

Zoom	Lens position		
	Upper most	Center (Reference value)	Down most
	VU	VC	VL
Wide	29.2	14.2	29.2
Tele	20.2	9.5	20.2

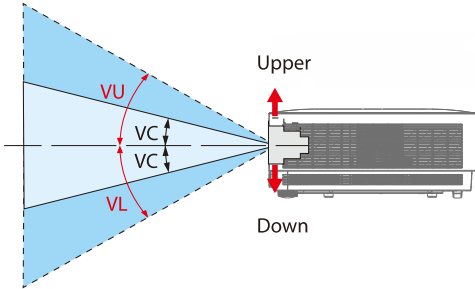

*Cable information*

Use shielded cables or cables attached ferrite cores so as not to interfere with radio and television reception.

For details, please refer to “5. Making Connections” in this user’s manual.

FCC Information (for USA only)

**WARNING:**

- The Federal Communications Commission does not allow any modifications or changes to the unit EXCEPT those specified by NEC Display Solutions of America, Inc. in this manual. Failure to comply with this government regulation could void your right to operate this equipment.
- This equipment has been tested and found to comply with the limits for a Class B digital device, pursuant to Part 15 of the FCC Rules. These limits are designed to provide reasonable protection against harmful interference in a residential installation. This equipment generates, uses, and can radiate radio frequency energy and, if not installed and used in accordance with the instructions, may cause harmful interference to radio communications. However, there is no guarantee that interference will not occur in a particular installation. If this equipment does cause harmful interference to radio or television reception, which can be determined by turning the equipment off and on, the user is encouraged to try to correct the interference by one or more of the following measures:
  - Reorient or relocate the receiving antenna.
  - Increase the separation between the equipment and receiver.
  - Connect the equipment into an outlet on a circuit different from that to which the receiver is connected.
  - Consult the dealer or an experienced radio / TV technician for help.

**Supplier’s declaration of conformity (for USA only)**

This device complies with Part 15 of FCC Rules. Operation is subject to the following two conditions.

(1) This device may not cause harmful interference, and (2) this device must accept any interference received, including interference that may cause undesired operation.

U.S. Responsible Party: NEC Display Solutions of America, Inc.  
Address: 3250 Lacey Rd, Ste 500  
Downers Grove, IL 60515  
Telephone Number: 630-467-3000  
Type of Product: Projector  
Equipment Classification: Class B Peripheral  
Model Number: NP-P506QL



*Disposing of your used product*



**In the European Union**

EU-wide legislation as implemented in each Member State requires that used electrical and electronic products carrying the mark (left) must be disposed of separately from normal household waste. This includes projectors and their electrical accessories. When you dispose of such products, please follow the guidance of your local authority and/or ask the shop where you purchased the product.

After collecting the used products, they are reused and recycled in a proper way. This effort will help us reduce the wastes as well as the negative impact to the human health and the environment at the minimum level.

The mark on the electrical and electronic products only applies to the current European Union Member States.

**Outside the European Union**

If you wish to dispose of used electrical and electronic products outside the European union, please contact your local authority and ask for the correct method of disposal.

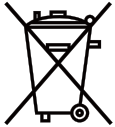

For EU: The crossed-out wheeled bin implies that used batteries should not be put to the general household waste! There is a separate collection system for used batteries, to allow proper treatment and recycling in accordance with legislation.

**According the EU directive 2006/66/EC, the battery can't be disposed improperly. The battery shall be separated to collect by local service.**

(for Germany only)

Machine Noise Information Regulation – 3.GPSGV,

The highest sound pressure level is less than 70 dB (A) in accordance with EN ISO 7779

Information of the AUDIO OUT mini jack

The AUDIO OUT mini jack does not support earphone/headphone terminal.

## Cautions for ensuring the projector's performance

- Do not install in places subject to vibrations or shocks.  
If installed in places where the vibrations from power sources and the like are conveyed, or in vehicles or on vessels, etc. the projector could be affected by vibrations or shocks that may damage internal parts and lead to malfunction.  
Install in a place not subject to vibrations or shocks.
- Do not install near high voltage power lines or power sources.  
The projector may be affected by interference if it is installed near a high voltage power line or a power source.
- Do not install or store in such places as those described below. Doing so could lead to malfunction.
  - Places where strong magnetic fields are generated
  - Places where corrosive gases are generated
- If intense light like laser beams enters from the lens, it could lead to malfunction.
- Consult your dealer before using in places where much cigarette smoke or dust is present.
- When using the projector at altitudes of about 1,600 m/5,500 feet or higher, be sure to set the [FAN MODE] to [HIGH ALTITUDE]. If not, the inside of the projector may get hot, leading to malfunction.
- When the projector is used at high altitudes (places where the atmospheric pressure is low), it may be necessary to replace the optical parts (light source, etc.) sooner than usual.
- About moving the projector
  - Be sure to mount the included lens cap to protect the lens from scratches.
  - Do not subject the projector to vibrations or strong shocks. The projector could be damaged otherwise.
- **Do not use the tilt feet for purposes other than adjusting the projector's tilt.**
- Improper handling, such as carrying the projector by the tilt feet or using it leaned against a wall, could lead to malfunction.
- Do not touch the surface of the projection lens with bare hands.
- Fingerprints or dirt on the surface of the projection lens will be enlarged and projected on the screen. Do not touch the surface of the projection lens.
- Do not unplug the power cord from the projector or the power outlet while projecting. Doing so could cause **deterioration of the projector's AC IN terminal or power plug** contact. To interrupt the AC power supply while images are being projected, use a power strip switch, a breaker, etc.
- About handling of the remote control
  - **The remote control will not work if the projector's remote signal sensor or the remote control's signal transmitter is exposed to strong light or if there are obstacles between them that obstruct the signals.**
  - **Operate the remote control from within 7 meters from the projector, pointing it at the projector's remote signal sensor.**
  - Do not drop the remote control or handle it improperly.
  - Do not let water or other liquids get on the remote control. Should the remote control get wet, wipe it off immediately.
  - Avoid using in hot and humid places as far as possible.
  - When planning not to use the remote control for long periods of time, remove both batteries.
- Take measures to prevent external light from shining on the screen.  
Make sure only the light from the projector shines on the screen. The less external light on the screen, the higher the contrast and the more beautiful the images.
- About screens  
Images will not be clear if there is dirt, scratches, discoloration, etc. on your screen. Handle the screen with care, protecting it from volatile substances, scratches and dirt.



### Clearance for Installing the Projector

When installing the projector, keep sufficient space around it, as described below. If not, the hot exhaust emitted from the projector may be taken back in.

Also, make sure no wind from an air-conditioner hits the projector.

The projector's heat control system may detect an abnormality (temperature error) and automatically shut off the power.

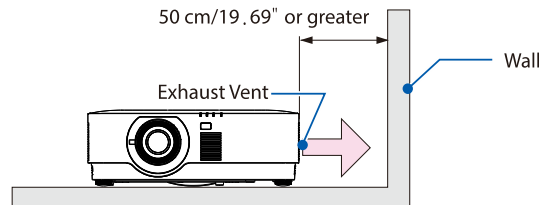

---

#### NOTE:

- In the above figure, it is assumed that there is sufficient space above the projector. There is also an intake vent on the back. Leave about 50 cm or more space behind, and even more space for installing the cables.
- 

### Precautions for Ceiling Installation

Do not install the projector in the following places. Attached substances such as oil, chemicals and moisture may cause deformation or cracks of the cabinet, corrosion of the metal parts, or malfunction.

- Outdoors and places with humid or dust
- Places exposed to oil smoke or steam
- Places where corrosive gases are generated

### About Copyright of original projected pictures:

Please note that using this projector for the purpose of commercial gain or the attraction of public attention in a venue such as a coffee shop or hotel and employing compression or expansion of the screen image with the following functions may raise concern about the infringement of copyrights which are protected by copyright law.

[ASPECT RATIO], [KEYSTONE], Magnifying feature and other similar features.

### Power management function

The projector has power management functions. To reduce power consumption, the power management functions (1 and 2) are factory preset as shown below. To control the projector from an external device via a LAN or serial cable connection, use the on-screen menu to change the settings for 1 and 2.

1. STANDBY MODE (Factory preset: NORMAL)

To control the projector from an external device, select [NETWORK STANDBY] or [HDBaseT] for [STANDBY MODE]. (→ page 41)

2. AUTO POWER OFF (Factory preset: 0)

To control the projector from an external device, select [0] for [AUTO POWER OFF]. (→page 41)

## Trademarks

- Microsoft, Windows, and Internet Explorer are either a registered trademark or trademark of Microsoft Corporation in the United States and/or other countries.
- The terms HDMI and HDMI High-Definition Multimedia Interface, and the HDMI Logo are trademarks or registered trademarks of HDMI Licensing Administrator, Inc. in the United States and other countries.



- HDBaseT™ and the HDBaseT Alliance logo are trademarks of the HDBaseT Alliance.



- DLP® and DLP logo are trademarks or registered trademarks of Texas Instruments in the United States and other countries.
- PLink trademark and logo are trademarks applied for registration or are already registered in Japan, the United States of America and other countries and areas.
- CRESTRON and CRESTRON ROOMVIEW are trademarks or registered trademarks of Crestron Electronics, Inc. in the United States and other countries.
- Ethernet is either a registered trademark or trademark of Fuji Xerox Co., Ltd.
- **Other product names and company logos mentioned in this user's manual may be the trademarks or registered trademarks of their respective holders.**
- GPL/LGPL Software Licenses  
The product includes software licensed under GNU General Public License (GPL), GNU Lesser General Public License (LGPL), and others.  
For more information on each software, see "readme.pdf" inside the "about GPL&LGPL" folder on the supplied CD-ROM.

# 1 Getting Started

## 1 Getting Started

### 1-1 Packing Checklist

Carefully unpack the projector and check that the following items are included:

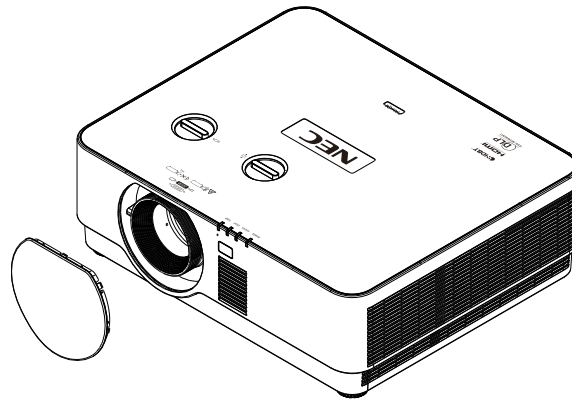

*Lens cap*  
79TL0851

*Projector*



*Remote Control*  
7N901261

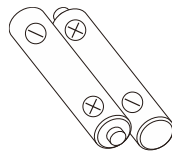

*Batteries*  
(AAA x 2)

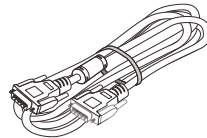

*Computer cable(VGA)*  
79TL0841

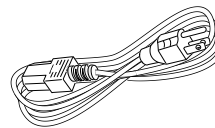

*Power Cord (US)*  
79TL0801

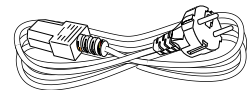

*Power Cord (EU)*  
79TL0811



*CD-ROM*  
(This User's Manual)  
7N953001

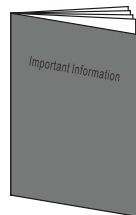

*Important Information*  
7N8R0401



*Security Sticker*  
24L67991

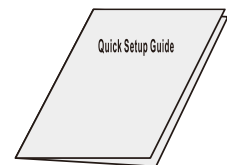

*Quick Setup Guide*  
7N8R0411

Contact your dealer immediately if any items are missing, appear damaged, or if the unit does not work. It is recommended that you keep the original packing material should you ever need to return the equipment for warranty service.

For North America only

- Limited warranty

For customers in Europe:

You will find our current valid Guarantee Policy on our Web Site:

<https://www.nec-display-solutions.com>

## 1-2 Views of Projector Parts

## Front-right View

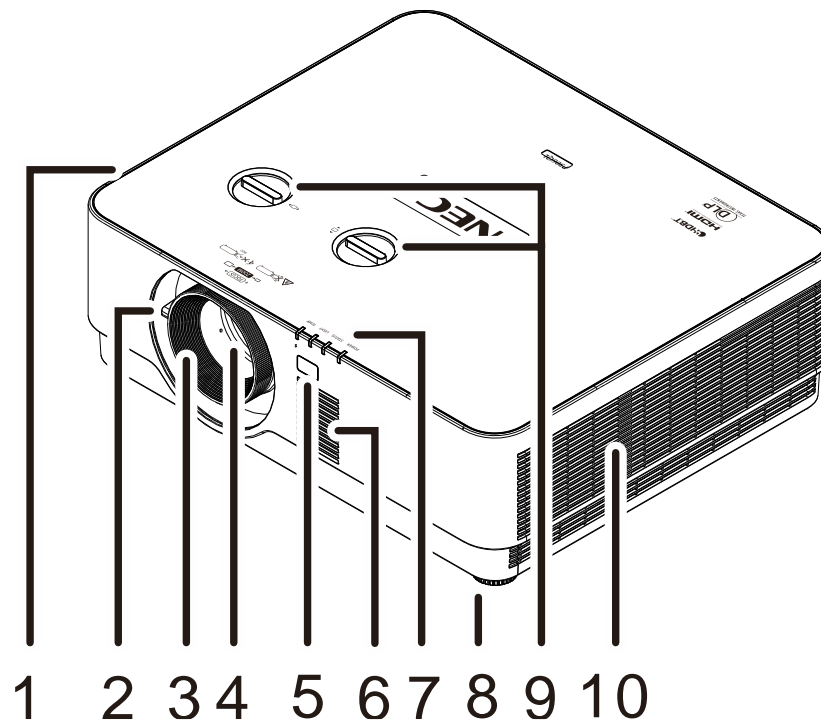

ITEM	LABEL	DESCRIPTION	SEE PAGE
1.	Intake Vent	Cool air intake	
2.	Zoom lever	Enlarges the projected image.	17
3.	Focus Ring	Focuses the projected image.	17
4.	Lens	Projection Lens.	
5.	Remote Sensor	Receives IR signal from remote control.	
6.	Monaural Speaker	Outputs audio sound.	
7.	Indicators	Display the messages of projector.	
8.	Tilt Foot	Rotate adjuster lever to adjust angle position.	14
9.	Lens Shift	Adjusts the image position.	15
10.	Exhaust Vent	Hot air exhaust	

**Caution**

Ventilation openings on the projector allow for good air circulation, which keeps the projector light source cool. Do not obstruct any of the ventilation openings.



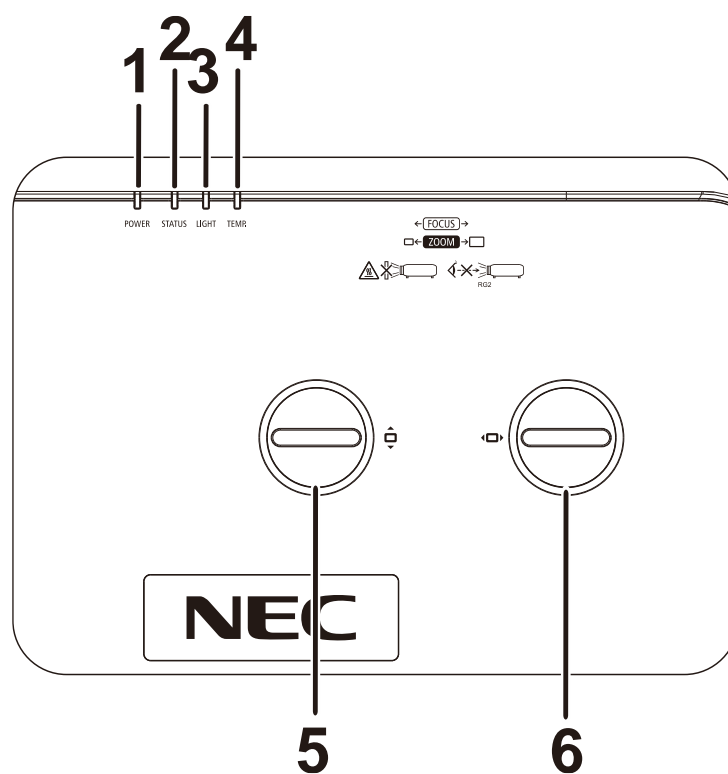

Top view

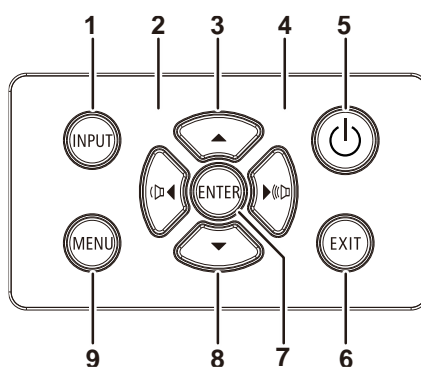

ITEM	LABEL	DESCRIPTION	SEE PAGE
1.	POWER Indicator	Display the power on/off sequence status.	48
2.	STATUS Indicator	Display the status of projector.	
3.	Light Indicator	Display the light source status.	
4.	Temp Indicator	Display the thermal status.	
5.	Vertical Lens Shift (UP / DOWN)	Adjusts the image position vertically.	16
6.	Horizontal Lens Shift (LEFT / RIGHT)	Adjusts the image position horizontally.	16

## Rear view-On-screen Display (OSD) buttons



ITEM	LABEL	DESCRIPTION	SEE PAGE
1.	INPUT	Enter the Source menu.	
2.		Navigates and changes settings in the OSD. Quick Menu – For Volume.	<a href="#">19</a>
3.		Navigates and changes settings in the OSD.	<a href="#">19</a>
4.		Navigates and changes settings in the OSD. Quick Menu – For Volume.	<a href="#">19</a>
5.		Turn the projector on or off.	<a href="#">12</a>
6.	EXIT	Return to last OSD page.	
7.	ENTER	Enter or confirm highlighted OSD menu item.	<a href="#">19</a>
8.		Navigates and changes settings in the OSD.	<a href="#">19</a>
9.	MENU	Opens and exits OSD menus.	<a href="#">19</a>

## Rear view (Terminal Panel)

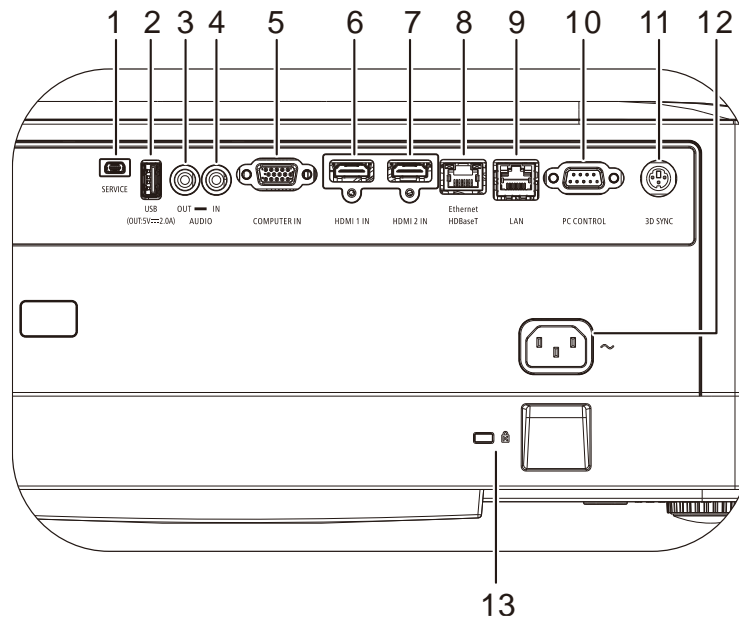

ITEM	LABEL	DESCRIPTION	SEE PAGE
1.	SERVICE	For service personnel only.	
2.	USB POWER (5V/2.0A)	5V POWER supply Only.. Note: Support 5V/2.0A output as long as the projector Power On.	
3.	AUDIO OUT	Connect an AUDIO cable for audio loop through.	
4.	AUDIO IN	Connect an AUDIO cable from the audio device.	
5.	COMPUTER IN	Connect an RGB cable from a computer.	
6.	HDMI 1 IN	Connect the HDMI cable from an HDMI device.	
7.	HDMI 2 IN	Connect the HDMI cable from an HDMI device.	
8.	Ethernet HDBaseT	Connect a LAN cable from Ethernet. Connect Cat5e/Cat6 cable from HDBaseT TX Box (VIDEO EXTENDER) for HDBaseT signal received.	
9.	LAN	Connect a LAN cable from Ethernet.	
10.	PC CONTROL	Connects RS-232 serial port cable for remote control.	
11.	3D-SYNC	Connect 3D-sync in cable from a computer or an enabled device.	
12.	AC IN	Connect the POWER cable.	
13.	Security chain opening 	Secures to permanent object with a Kensington Lock system.	46

*Note:*

- To use this feature, you must plug in the connector before turn on/off the projector.
- Do not use this jack for anything other than intended use.

*Note:*

As a safety precaution, disconnect all power to the projector and connecting devices before making connections.



## Bottom view

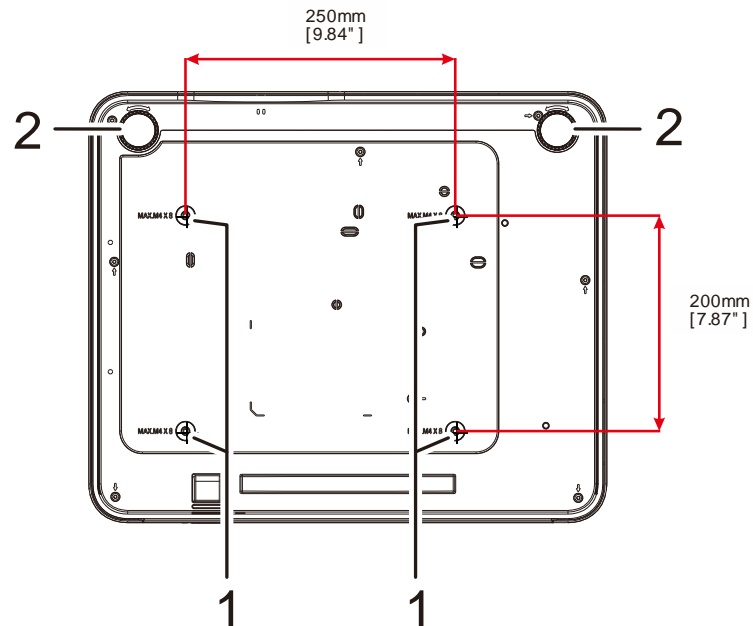

ITEM	LABEL	DESCRIPTION	SEE PAGE
1.	Ceiling Mount Holes	Contact your dealer for information on mounting the projector on a ceiling.	
2.	Tilt Foot	Rotate adjuster lever to adjust angle position.	14

*Note:*

*When installing, ensure that you use only UL Listed ceiling mounts.*

*For ceiling installations, use approved mounting hardware and M4 screws with a maximum screw depth of 8 mm (0.315 inch).*

*The construction of the ceiling mount must be of a suitable shape and strength. The ceiling mount load capacity must exceed the weight of the installed equipment, and as an additional precaution be capable of withstanding three times the weight of the equipment over a period of 60 seconds.*

## Reference drawings for stand

Please hire an installation service provider (for a fee) for the design and manufacture of a customized stand to be used for portrait projection. Please ensure that the design complies with the following conditions:

- Use the 4 screw holes at the back of the projector to secure it to the stand.  
Screw hole center dimension: 250 × 200 mm  
Screw hole dimension on the projector: M4 with the maximum depth 8 mm
- Horizontal adjustment mechanism (for example, bolts and nuts in 4 places)
- Please design the stand so that it does not easily topple over.

The drawing showing the dimensional requirements is not an actual stand design drawing.

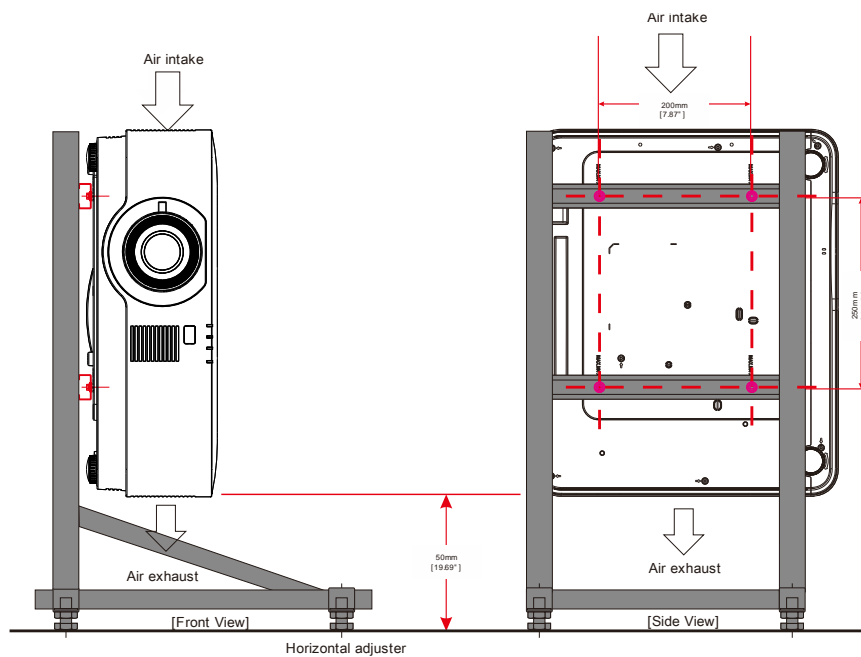

## 1-3 Remote Control Specification

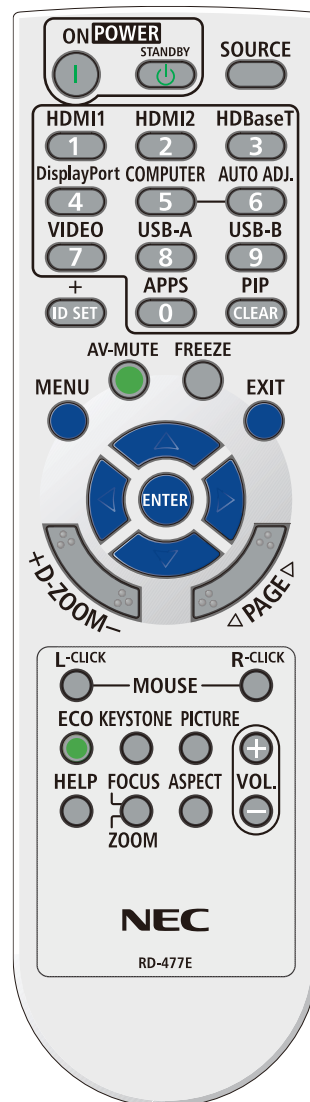
**Note:**

1. Avoid using the projector with bright fluorescent lighting turned on. Certain high-frequency fluorescent lights can disrupt remote control operation.
2. Be sure nothing obstructs the path between the remote control and the projector. If the path between the remote control and the projector is obstructed, you can bounce the signal off certain reflective surfaces such as projector screens.
3. The buttons and keys on the projector have the same functions as the corresponding buttons on the remote control. This user's manual describes the functions based on the remote control.

Key Name	Short
ON	Power ON
STANDBY	Power OFF
SOURCE	Display Menu of INPUT SELECT
HDMI1	Change Input to HDMI1
HDMI2	Change Input to HDMI2
HDBaseT	Change Input to HDBaseT
DispalyPort	-
COMPUTER	Change Input to COMPUTER
AUTO ADJ.	-
VIDEO	-
USB-A	-
USB-B	-
ID	-
APPS	-
PIP	-
MENU	Menu Operation
AV-MUTE	AV Mute ON / OFF
FREEZE	Freeze ON / OFF
EXIT	Menu Operation
UP	Menu Operation
ENTER	Menu Operation
LEFT	Menu Operation
RIGHT	Menu Operation
DOWN	Menu Operation
D-ZOOM +	Zoom Up
D-ZOOM -	Zoom Down
PAGE UP	-
PAGE DOWN	-
L-CLICK	-
R-CLICK	-
ECO	Display Menu of LIGHT MODE tab directly
KEystone	Display Menu of DISPLAY tab and set UI focus to KEystone
PICTURE	Toggle display direct menu of CONTRAST/BRIGHTNESS/SHARPNESS
VOLUME +	Adjust Volume Up directly
HELP	Display Menu of INFO tab directly
FOCUS/ZOOM	-
ASPECT	Display Menu of ADJUST tab directly and set UI focus to ASPECT RATIO
VOLUME -	Adjust Volume Down directly

### 1-4 Remote Control Operating Range

The remote control uses infrared transmission to control the projector. It is not necessary to point the remote directly at the projector. Provided you are not holding the remote perpendicular to the sides or the rear of the projector, the remote will function well within a radius of about 7 meters (23 feet) and 30 degrees above or below the projector level. If the projector does not respond to the remote control, move a little closer.

### 1-5 Projector and Remote Control Buttons

The projector can be operated using the remote control or the buttons on the top of the projector. All operations can be carried out with the remote control; however, the buttons on the projector are limited in use.

## 2 Setup and Operation

### 2 Setup and Operation

#### 2-1 Inserting the Remote Control Batteries

1. Remove the battery compartment cover by sliding the cover in the direction of the arrow.

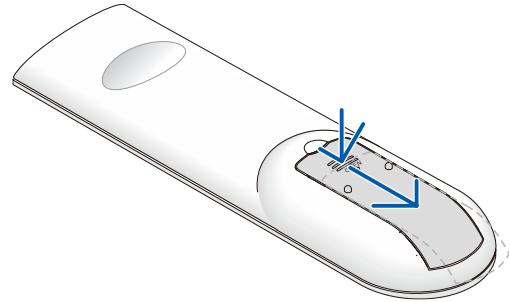

2. Insert the battery with the positive side facing up.

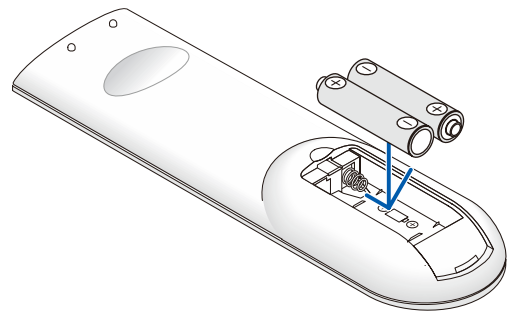

3. Replace the cover.

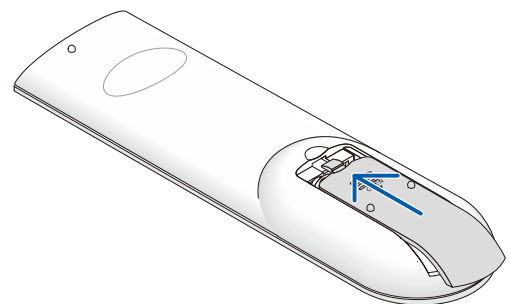



#### *Remote Control Precautions*

1. Only use AAA batteries (Alkaline batteries are recommended).
2. Dispose of used batteries according to local ordinance regulations.
3. Remove the batteries when not using the projector for prolonged periods.
4. RISK OF EXPLOSION IF BATTERY IS REPLACED BY AN INCORRECT TYPE.
5. DISPOSE OF USED BATTERIES ACCORDING TO THE INSTRUCTIONS.

## 2-2 Starting and Shutting down the Projector

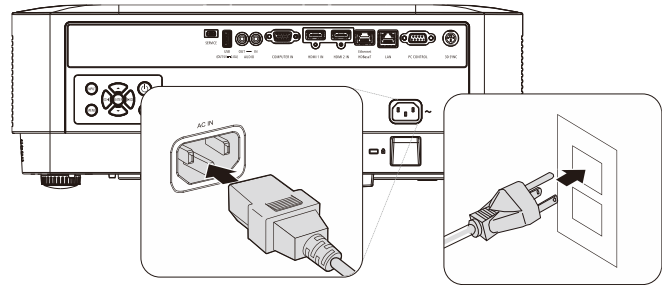
1. Securely connect the power cord and signal cable. When connected, the power led will flash green to solid green.

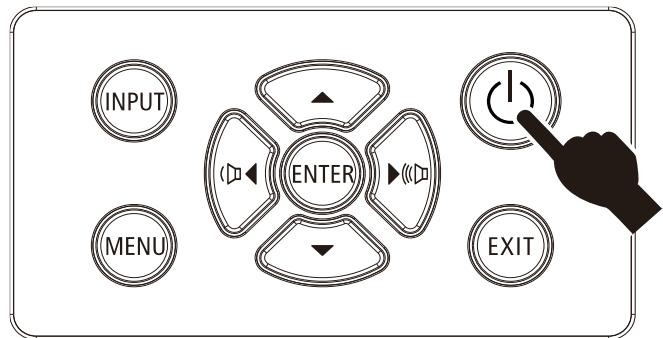

2. Turn on the light source by pressing “” button on the projector or “” on the remote control.  
The PWR LED will now flash blue.  
The startup screen will display in approximately 30 seconds. The first time you use the projector, you can select your preferred language from quick menu after the startup screen display. (See [Setting the OSD Language](#) on page 20)

**Caution:**

Be sure to connect the projector and the computer (signal source) to the same earth point.

If the projector and the computer (signal source) will be connected to different earth points, fluctuations in the earth potential may cause fire or smoke.

3. If more than one input device is connected, press the SOURCE button on the remote control or INPUT button on the projector cabinet and use ▲▼ to scroll among devices.

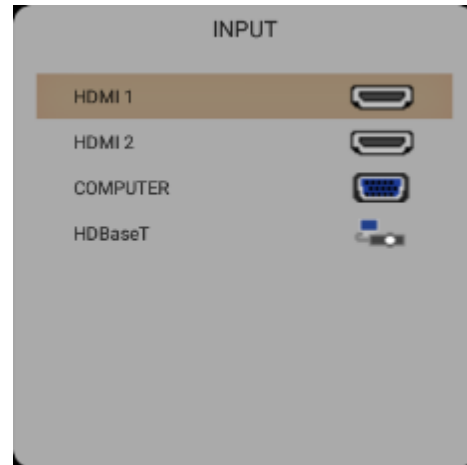

- HDMI 1: High-Definition Multimedia Interface compatible
- HDMI 2: High-Definition Multimedia Interface compatible
- COMPUTER: Analog RGB
- HDBaseT: Support for distribution of HD video, digital audio content, RS232, RJ45 and IR function over standard CAT5e/6 LAN cable.

Note:

It is recommended to use a certified TX box (VIDEO EXTENDER) – Rexton (EVBMN-110L38) for the HDBaseT function and there is no guarantee of full response when other brands of TX box are used..

Using a single HDBaseT CAT5e cable, the projector supports an HDBaseT connection distances to 100m/328ft.

4. When the “POWER OFF ARE YOU SURE” message appears, press the POWER button. The projector turns off.

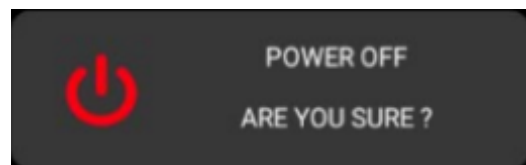

**Caution:**

*Do not unplug the power cord until the POWER LED stops flashing – indicating the projector has cooled down.*



### 2-3 Adjusting the Projector Level

Take note of the following when setting up the projector:

- *The projector table or stand should be level and sturdy.*
- *Position the projector so that it is perpendicular to the screen.*
- *Ensure the cables are in a safe location. You could trip over them.*

1. To raise the level of the projector, twist the adjusters counter clockwise.

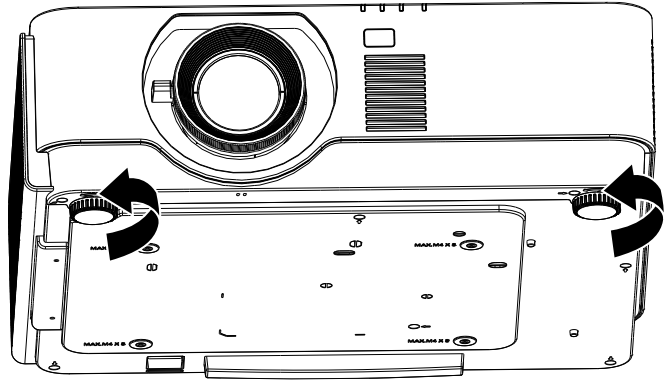

2. To lower the level of the projector, lift the projector and twist the adjusters clockwise.

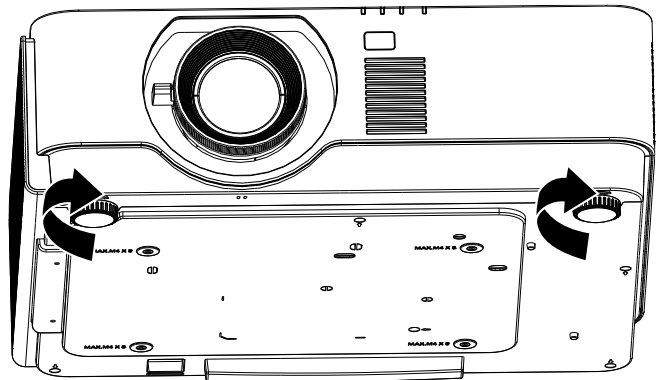

## 2-4 Adjusting Projected Image Position Using Lens Shift

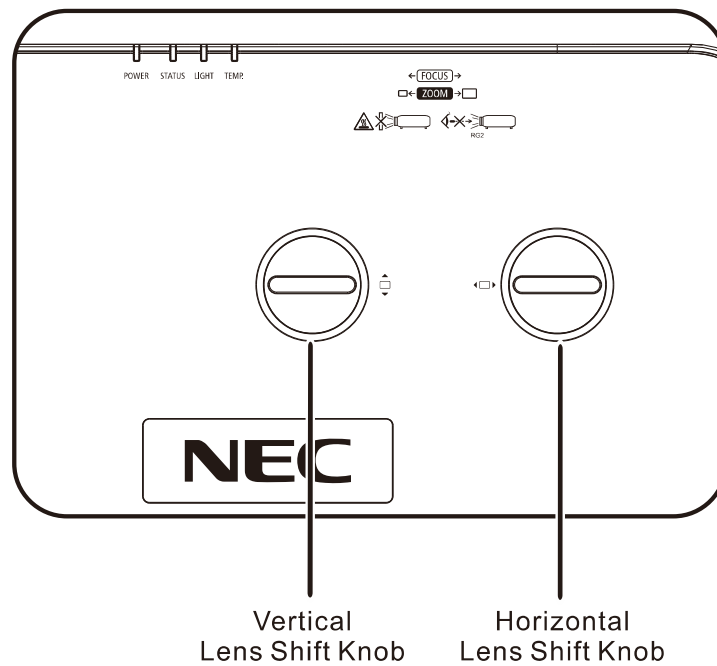

The Lens Shift feature provides a lens shift function that can be used to adjust the position of the projected image either horizontally or vertically within the range detailed below.

Shift is a unique system that provides lens shift while maintaining a much higher ANSI contrast ratio than traditional lens shift systems.

**Note:**

*Do not rotate lens shift knob further under click sound and lightly press the knob to rotate back.*

### Adjusting the vertical image position

The vertical image height can be adjusted around 60% for UHD of offset position. Note that the maximum vertical image height adjustment can be limited by the horizontal image position. For example it is not possible to achieve the maximum vertical image position height detailed above if the horizontal image position is at maximum. Please consult the Shift Range diagram below for further clarification.

### Adjusting the horizontal image position

With the lens horizontal image position can be adjusted to a maximum of 20% for UHD of the image width. Note that the maximum horizontal image height adjustment can be limited by the vertical image position. For example it is not possible to achieve the maximum horizontal image position if the vertical image position is at maximum. Please consult the Shift Range diagram below for further clarification.

Lens Shift Range Diagram

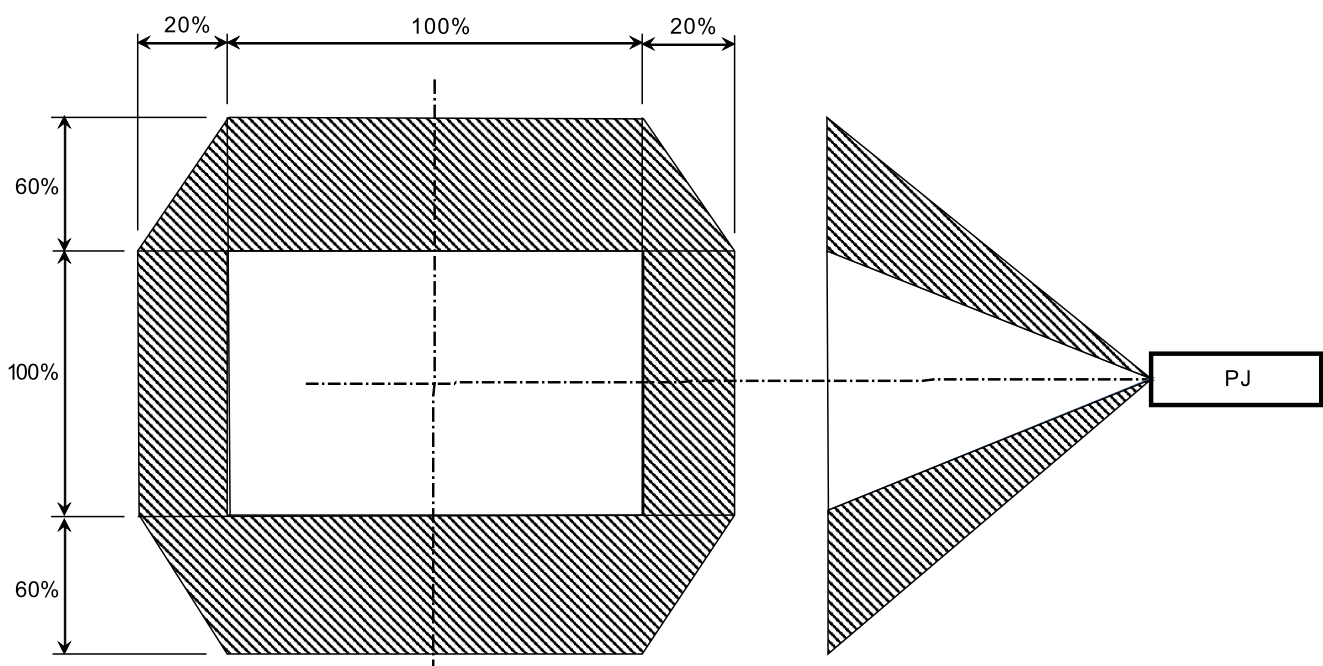

## 2-5 Adjusting the Zoom, Focus and Keystone

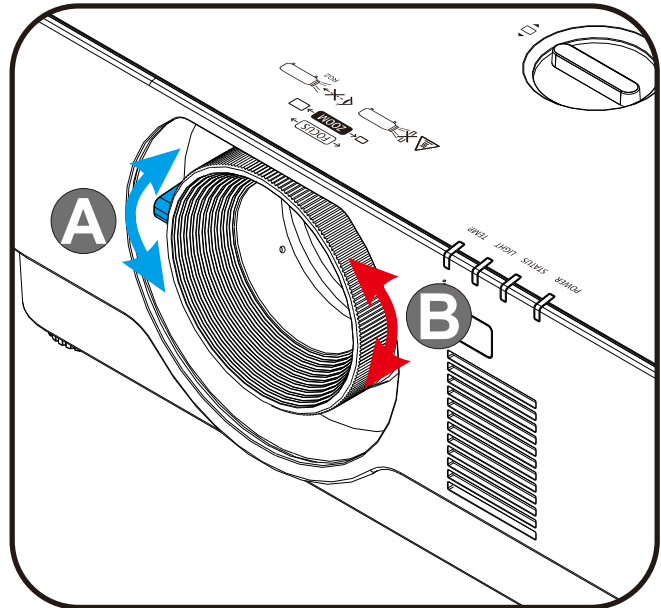

1. Use the Image-zoom control (on the projector only) to resize the projected image and screen size **A**.
2. Use the Image-focus control (on the projector only) to sharpen the projected image **B**.

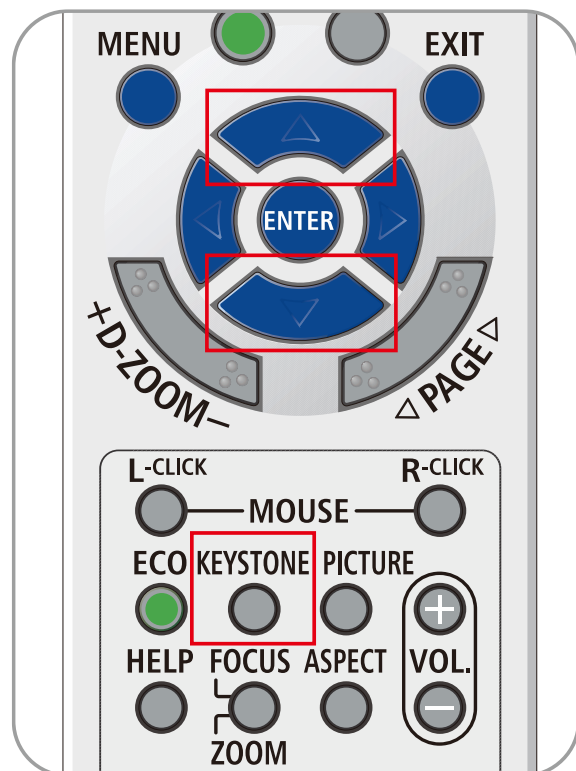

3. Press the Keystone and ▲▼ button (on the remote) to selected V (Vertical) keystone.



## 2-6 Adjusting the Volume

1. Press the Volume +/- buttons on the remote control or press the  /  buttons on the keypad to adjust Volume +/-.

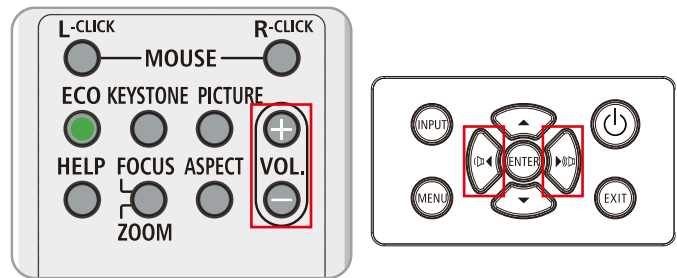

2. The volume control appears on the display

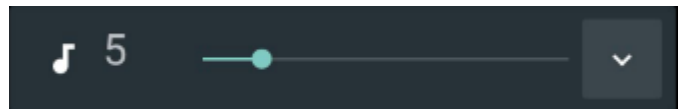

3. Press the AV-MUTE button to turn off the image and volume (This feature is available only on the remote).

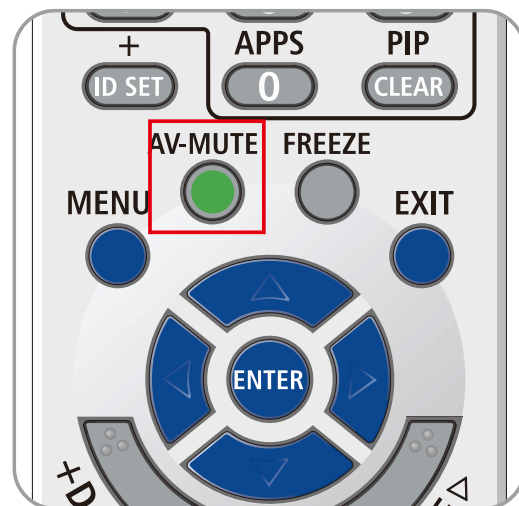

## 3 On-Screen Display (OSD) Menu Settings

# 3 On-Screen Display (OSD) Menu Settings

### 3-1 OSD Menu Controls

The projector has an OSD that lets you make image adjustments and change various settings.

#### Navigating the OSD

You can use the remote control cursor buttons or the buttons on the projector to navigate and make changes to the OSD. The following illustration shows the corresponding buttons on the projector.

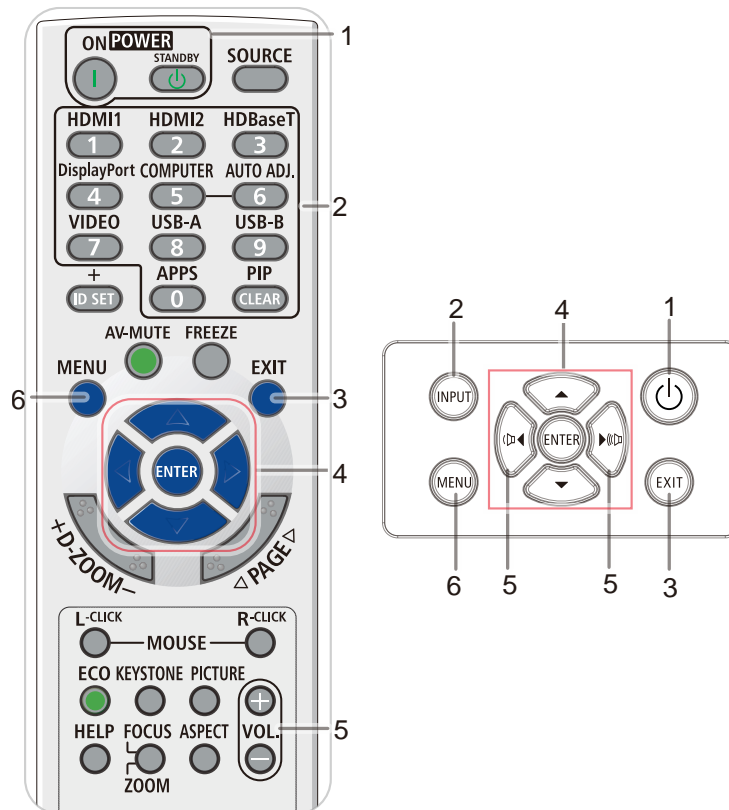

1. To enter the OSD, press the MENU button.
2. There are six menus. Press the cursor ◀ / ▶ buttons to move through the menus.
3. Press the cursor ▲ / ▼ buttons to move up and down in a menu.
4. Press the cursor ◀ / ▶ buttons to change values for settings.
5. Press the MENU button to close the OSD or leave a submenu. Press the EXIT button to return to the previous menu.



**Note:**

Depending on the video source, not all items in the OSD are available. For example, the Horizontal/Vertical Position items in the Computer menu can only be modified when connected to a PC. Items that are not available cannot be accessed and are grayed out.

### 3-2 Setting the OSD Language

Set the OSD language to your preference before continuing.

1. Press the MENU button. Press the cursor ◀▶ button to navigate to SETUP
2. Press the cursor ▲▼ button until LANGUAGE is highlighted.



3. Press the cursor button until the language you want is highlighted.



4. Press the MENU button to close the OSD.

## 3-3 OSD Menu Overview

Use the following illustration to quickly find a setting or determine the range for a setting.

Main Menu	Sub Menu		Settings	
INPUT	HDMI	VIDEO LEVEL	AUTO, NORMAL, ENHANCED	
	COMPUTER	H POSITION	-5~5	
		V POSITION	-5~5	
		PHASE	0~100	
		CLOCK	-5~5	
		WXGA	AUTO, ON, OFF	
	3D	GLASSES	DLP-LINK, IR	
		SYNC INVERT	OFF, ON	
	AUTO SOURCE		OFF, ON	
TEST PATTERN		OFF, GRID		
ADJUST	REFERENCE		HIGH-BRIGHT, PRESENTATION, VIDEO, MOVIE, sRGB, DICOM, USER, HDR	
	DETAIL SETTINGS	GAMMA CORRECTION	1.8, 2, 2.2, 2.4, B&W, LINEAR	
		COLOR TEMPERATURE	WARM, NORMAL, COLD	
		DYNAMIC CONTRAST	OFF, ON	
		WHITE BALANCE	CONTRAST R	0~200
			CONTRAST G	0~200
			CONTRAST B	0~200
			BRIGHTNESS R	-100~100
			BRIGHTNESS G	-100~100
			BRIGHTNESS B	-100~100
		ADVANCED	WHITE PEAKING	0~10
	MEMC		OFF, LOW, MEDIUM, HIGH	
	IMAGE PEAKING		OFF, 0~10	
	COLOR CORRECTION	COLOR	RED, GREEN, BLUE, YELLOW, MAGENTA, CYAN, WHITE	
		HUE	0~100	
		SATURATION	0~100	
		GAIN	0~100	
	CONTRAST		0~100	
	BRIGHTNESS		0~100	
	SHARPNESS		0~31	
	AUDIO	VOLUME	0~31	
RESET		CANCEL, OK		



### 3 On-Screen Display (OSD) Menu Settings

Main Menu	Sub Menu		Settings
DISPLAY	ASPECT RATIO		FILL, 4:3, 16:9, LETTER BOX
	DIGITAL ZOOM		-10~10
	KEystone		-30~30
	ORIENTATION		DESKTOP FRONT, DESKTOP REAR, CEILING FRONT, CEILING REAR
NETWORK	CONNECT		DISABLE, ENABLE
	DHCP		OFF, ON
	IP ADDRESS		0~ 255, 0~ 255, 0~ 255, 0~ 255
	SUBNET MASK		0~ 255, 0~ 255, 0~ 255, 0~ 255
	GATEWAY		0~ 255, 0~ 255, 0~ 255, 0~ 255
	DNS		0~ 255, 0~ 255, 0~ 255, 0~ 255
	APPLY		CANCEL, OK
	AMX BEACON		OFF, ON
SETUP	LIGHT MODE	ECO MODE	NORMAL, ECO
		ADJUST	30 ~100
		CONSTANT BRIGHTNESS	OFF, ON
	FAN MODE		NORMAL, HIGH ALTITUDE
	REMOTE SENSOR		ALL, FRONT, BACK
	STANDBY	STANDBY MODE	NORMAL, NETWORK STANDBY, HDBaseT
		AUTO POWER OFF	0~180
		OFF TIMER	0~600
	DIRECT POWER ON		OFF, ON
	MENU	MESSAGE DISPLAY	OFF, ON
		MENU POSITION	CENTER, UP, DOWN, LEFT, RIGHT
		DISPLAY TIME	MANUAL, AUTO 5SEC, AUTO 15SEC, AUTO 45SEC
		BACKGROUND	BLUE, BLACK
	SECURITY	CONTROL PANEL LOCK	OFF, ON
	LANGUAGE		ENGLISH, DEUTSCH, FRANCAIS, ITALIANO, ESPAÑOL, SVENSKA, 日本語, DANSK, PORTUGUÊS, MAGYAR, POLSKI, NEDERLANDS, SUOMI, NORSK, TÜRKÇE, РУССКИЙ, عربي, ΕΛΛΗΝΙΚΑ, 한국어, ROMÂNĂ, HRVATSKI, БЪЛГАРСКИ, INDONESIA, ไทย, हिन्दी, ئۇيغۇر, 繁體中文
	RESET ALL		CANCEL, OK
INFO.	INPUT TERMINAL		
	SOURCE NAME		
	LIGHT HOURS USED		
	IP ADDRESS		
	VERSION		
	SERIAL NUMBER		

3-4 INPUT Menu

*Attention*  
 All of display mode parameters when changed will be saved to user mode.

Press the MENU button to open the OSD menu. Press the cursor ◀▶ button to move to the INPUT Menu. Press the cursor ▲▼ button to move up and down in the INPUT menu. Press ◀▶ to enter and change values for settings.



ITEM	DESCRIPTION
HDMI	Press the cursor ◀▶ button to enter and set the HDMI.
COMPUTER	Press Enter to enter the Computer menu. See <a href="#">COMPUTER Menu</a> on page 24.
3D	Press Enter to enter the 3D menu. See <a href="#">3D Setting</a> on page 25.
AUTO SOURCE	Press the cursor ◀▶ button to enter and set the Auto Source.
TEST PATTERN	Press the cursor ◀▶ button to enter and select internal Test Pattern.

*Note:*  
 To enjoy the 3D function, first enable the Play Movie in 3D setting found in your DVD device under the 3D Disc Menu.

#### COMPUTER Menu

Press the Menu button to open the OSD menu. Press ◀▶ to move to the ADJUST menu. Press ▼▲ to move to the COMPUTER menu and then press Enter or ▶. Press ▼▲ to move up and down in the COMPUTER menu.

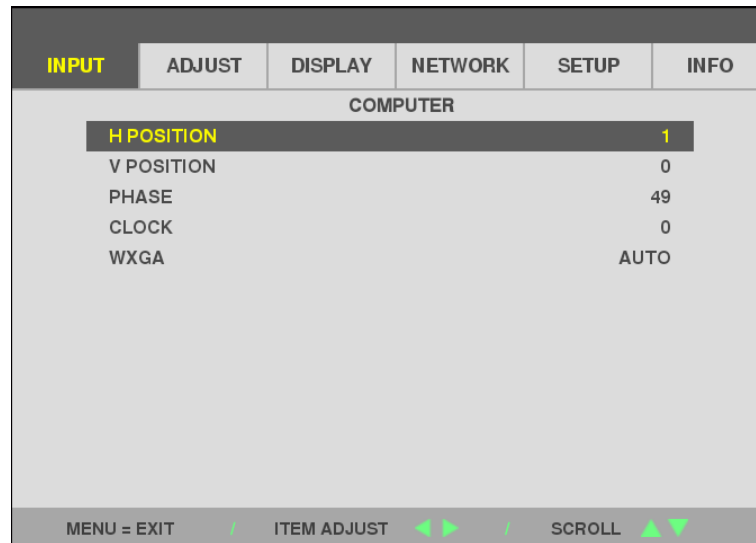

ITEM	DESCRIPTION
H POSITION	Press the cursor ◀▶ button to enter and adjust the display position to left or right.
V POSITION	Press the cursor ◀▶ button to enter and adjust the display position to up or down.
PHASE	Press the cursor ◀▶ button to enter and adjust the A/D clock timing phase..
CLOCK	Press the cursor ◀▶ button to enter and adjust the A/D sampling dots.
WXGA	Press the cursor ◀▶ button to select WXGA mode support or not. Auto: auto detection, on: support 1680x1050 60Hz(16:10), off: support 1400x1050 60Hz(4:3)

3D Setting

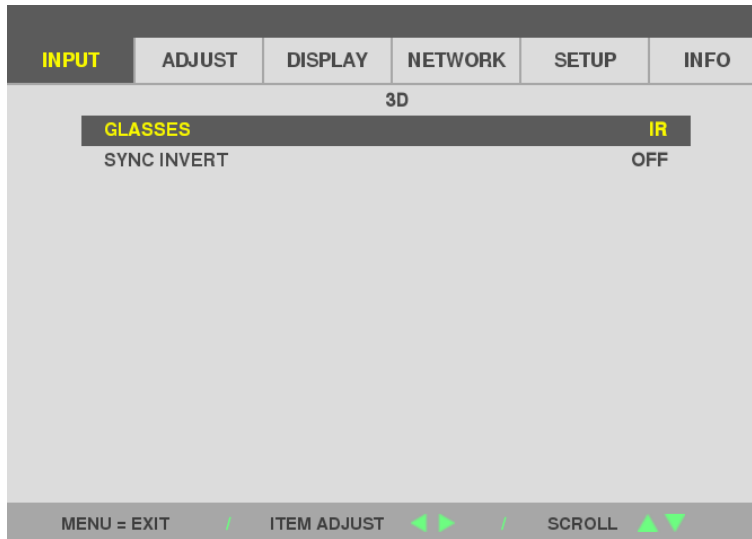

ITEM	DESCRIPTION
GLASSES	Press the cursor ◀▶ button to enter and select different 3D mode.
SYNC INVERT	Press the cursor ◀▶ button to enter and enable or disable 3D Sync Invert.

Note:

1. The 3D OSD menu item is gray if there is no appropriate 3D source. This is the default setting.
2. When the projector is connected to an appropriate 3D source, the 3D OSD menu item is enabled for selection.
3. Use 3D glasses to view a 3D image.
4. You need 3D content from a 3D DVD or 3D media file.
5. You need to enable the 3D source (some 3D DVD content may have a 3D on-off selection feature).
6. You need DLP link 3D or IR 3D shutter glasses. With IR 3D shutter glasses, you need to install a driver on your PC and connect a USB emitter.
7. The 3D mode of the OSD needs to match the type of glasses (DLP link or IR 3D).
8. Power on the glasses. Glasses normally have a power on -off switch. Each type of glasses has their own configuration instructions. Please follow the configuration instructions that come with your glasses to finish the setup process.
9. Passive 3D is not going to support thru 3D Sync In/Out.
10. It takes around 30 seconds to enable or disable 3D function.

Note:

Since different types of glass (DLP link or IR shutter glass) have their own setting instructions, Please follow the guide to finish the setup process.

### 3-5 ADJUST Menu

Press the MENU button to open the OSD menu. Press the cursor ◀▶ button to move to the ADJUST Menu. Press the cursor ▲▼ button to move up and down in the ADJUST menu. Press ◀▶ to enter and change values for settings.



ITEM	DESCRIPTION
REFERENCE	Press the cursor ◀▶ button to enter and set the Reference Mode.
DETAIL SETTINGS	Press Enter to enter the Detail Settings menu. See <a href="#">3D Setting</a> on page 25.
COLOR CORRECTION	Press Enter to enter the Color Correction menu. See page 30 for more information on <a href="#">COLOR CORRECTION</a>
CONTRAST	Press the cursor ◀▶ button to enter and adjust the display Contrast.
BRIGHTNESS	Press the cursor ◀▶ button to enter and adjust the display Brightness.
SHARPNESS	Press the cursor ◀▶ button to enter and adjust the display Sharpness.
AUDIO	Press Enter to enter the Audio menu and adjust the volume
RESET	Press Enter to reset all picture settings to default values.

DETAIL SETTINGS Menu

Press the MENU button to open the OSD menu. Press ◀▶ to move to the ADJUST menu. Press ▲▼ to move to the DETAIL SETTINGS menu and then press Enter or ▶. Press ▲▼ to move up and down in the DETAIL SETTINGS menu.

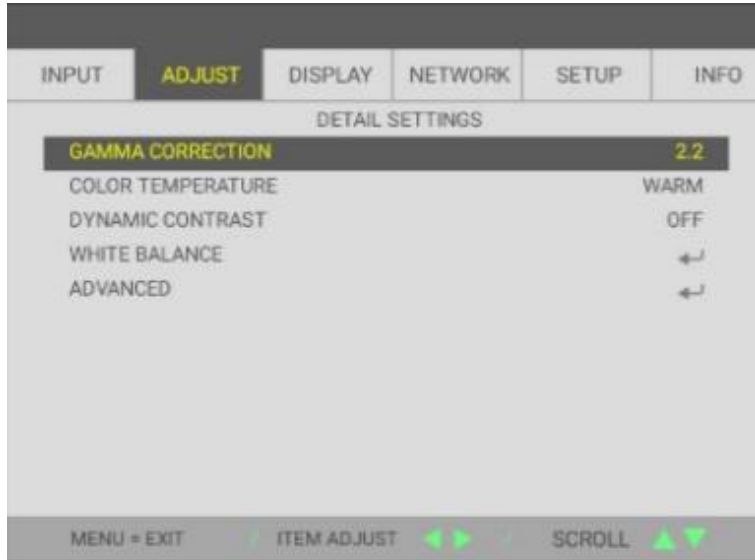

ITEM	DESCRIPTION
GAMMA CORRECTION	Press the cursor ◀▶ button to enter and adjust the Gamma Correction of the display.
COLOR TEMPERTURE	Press the cursor ◀▶ button to enter and adjust the Color Temperature.
DYNAMIC CONTRAST	Press the cursor ◀▶ button to enter and enable or disable the Dynamic Contrast.
WHITE BALANCE	Press the Enter button to enter the White Balance sub menu. See <a href="#">WHITE BALANCE</a> on page 28
ADVANCED	Press Enter to enter the Advanced menu. See <a href="#">ADVANCED Feature</a> on page 29.

WHITE BALANCE

Press the ENTER button to enter the WHITE BALANCE sub menu.



ITEM	DESCRIPTION
CONTRAST R	Press the ◀▶ buttons to adjust the Red Contrast.
CONTRAST G	Press the ◀▶ buttons to adjust the Green Contrast.
CONTRAST B	Press the ◀▶ buttons to adjust the Blue Contrast.
BRIGHTNESS R	Press the ◀▶ buttons to adjust the Red Brightness.
BRIGHTNESS G	Press the ◀▶ buttons to adjust the Green Brightness.
BRIGHTNESS B	Press the ◀▶ buttons to adjust the Blue Brightness.

ADVANCED Feature

Press the ENTER button to enter the ADVANCED sub menu.

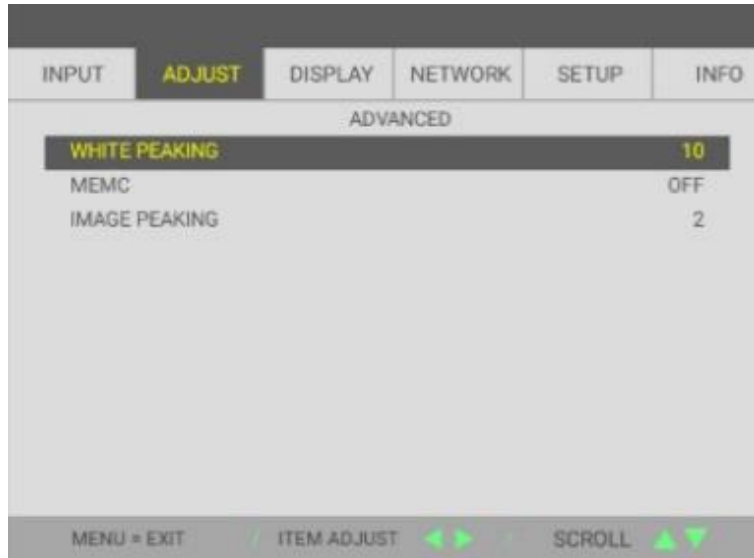

ITEM	DESCRIPTION
WHITE PEAKING	Press the cursor ◀▶ button to enter and adjust the White Peaking value.
MEMC	Press the ◀▶ buttons to select different MEMC level.
IMAGE PEAKING	Press the ◀▶ buttons to adjust motion adaptive sharpness enhancement (2D Peaking) value.

*Note:*  
*IMAGE PEAKING works when the input terminal is HDMI 1/2 or HDBaseT.*



COLOR CORRECTION

Press the Menu button to open the OSD menu. Press ◀▶ to move to the ADJUST menu. Press ▼▲ to move to the COLOR CORRECTION menu and then press Enter or ▶. Press ▼▲ to move up and down in the COLOR CORRECTION menu.



ITEM	DESCRIPTION
COLOR	Press the ◀▶ buttons to select RED, GREEN, BLUE, YELLOW, MAGENTA, CYAN or WHITE.
RED	Select to enter the Red Color Correction. Press the ◀▶ buttons to adjust the Hue, Saturation, and Gain.
GREEN	Select to enter the Green Color Correction. Press the ◀▶ buttons to adjust the Hue, Saturation, and Gain.
BLUE	Select to enter the Blue Color Correction. Press the ◀▶ buttons to adjust the Hue, Saturation, and Gain.
YELLOW	Select to enter the Yellow Color Correction. Press the ◀▶ buttons to adjust the Hue, Saturation, and Gain.
MAGENTA	Select to enter the Magenta Color Correction. Press the ◀▶ buttons to adjust the Hue, Saturation, and Gain.
CYAN	Select to enter the Cyan Color Correction. Press the ◀▶ buttons to adjust the Hue, Saturation, and Gain.
WHITE	Select to enter the White Color Correction. Press the ◀▶ buttons to adjust the Red, Green, and Blue.

### 3-6 DISPLAY Menu

Press the MENU button to open the OSD menu. Press the cursor ◀▶ button to move to the DISPLAY menu. Press the cursor ▲▼ button to move up and down in the DISPLAY menu. Press ◀▶ to enter and change values for settings.

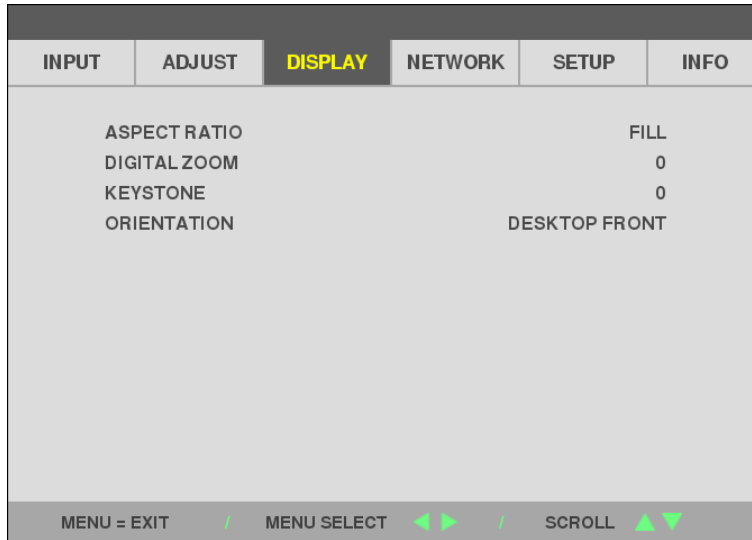

ITEM	DESCRIPTION
ASPECT RATIO	Press the cursor ◀▶ button to enter and adjust the video Aspect Ratio.
DIGITAL ZOOM	Press the cursor ◀▶ button to enter and adjust the Digital Zoom.
KEYSTONE	Press the cursor ◀▶ button to enter and adjust the Keystone.
ORIENTATION	Press the cursor ◀▶ button to enter and choose from four Orientation methods.

*Note:*

*The default aspect ratio "FILL" is set to fit the native resolution (16:9) of projector. If the input resolution is not 16:9 ASPECT RATIO, such as 1280 x 1024(4:3), the image would be scaling to FILL 16:9 with distortion.*

### 3-7 NETWORK Menu

Press the MENU button to open the OSD menu. Press the cursor ◀▶ button to move to the NETWORK menu. Press the cursor ▲▼ button to move up and down in the NETWORK menu. Press ◀▶ to enter and change values for settings.



ITEM	DESCRIPTION
CONNECT	Displays the network connection status.
DHCP	Press ◀▶ to turn DHCP On or Off. Note: If you select DHCP Off, complete the IP Address, Subnet Mask, Gateway, and DNS fields.
IP ADDRESS	Enter a valid IP address if DHCP is turned off.
SUBNET MASK	Enter a valid Subnet Mask if DHCP is turned off.
GATEWAY	Enter a valid Gateway address if DHCP is turned off.
DNS	Enter a valid DNS name if DHCP is turned off.
APPLY	Press Enter to confirm settings.
AMX BEACON	Press the cursor ◀▶ button to enter and adjust the AMX Beacon.

### LAN\_RJ45

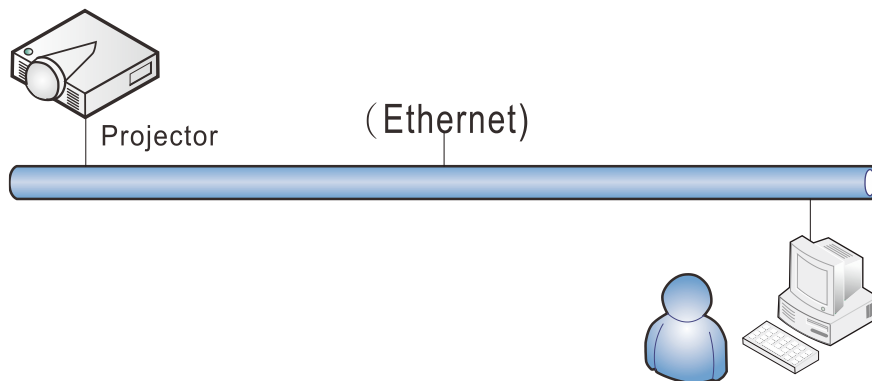

### Wired LAN Terminal functionalities

Remote control and monitoring of a projector from a PC (or Laptop) via wired LAN is also possible. Compatibility with Crestron / AMX (Device Discovery) enables not only collective projector management on a network but also management from a control panel on a PC (or Laptop) browser screen.

### Supported External Devices

This projector is supported by the specified commands of the Crestron Electronics controller and related software (ex, RoomView<sup>®</sup>).

<http://www.crestron.com/>

This projector is supported by AMX ( Device Discovery ).

<http://www.amx.com/>

This projector supports all commands of PJLink Class1 (Version 1.00).

<http://pjlink.jbmia.or.jp/english/>

For more detail of information about the diverse types of external devices which can be connected to the LAN/RJ45 port and remote/control the projector, as well as the related control commands supporting for each external device, kindly please get contact with the Support-Service team directly.

#### LAN\_RJ45

1. Connect an RJ45 cable to RJ45 ports on the projector and the PC (Laptop).

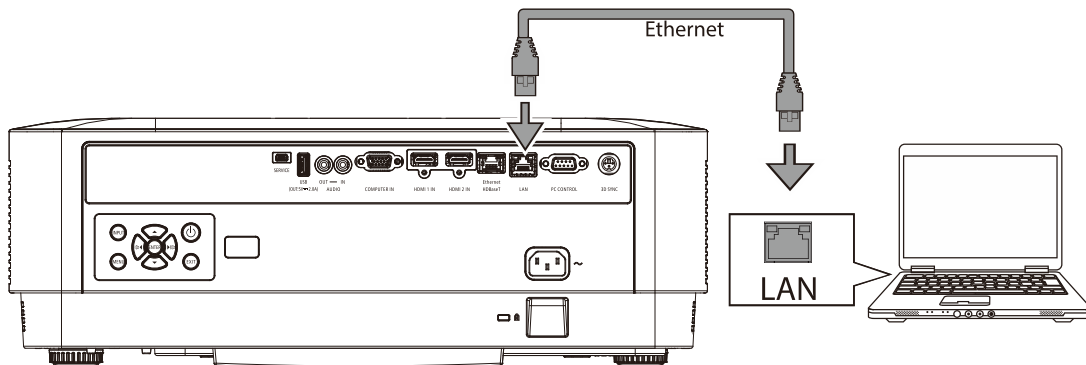

2. On the PC (Laptop), select Start → Settings → Network & Internet → Ethernet → Change adapter options.

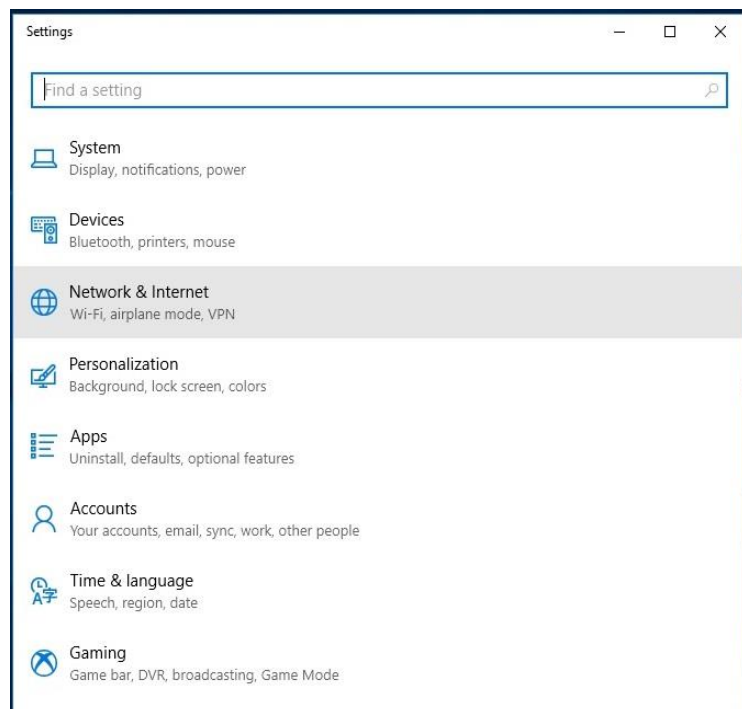
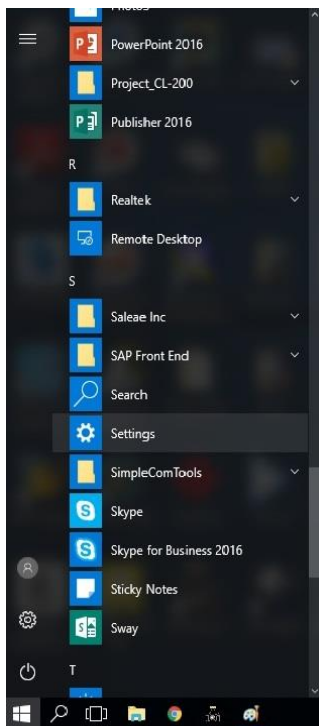

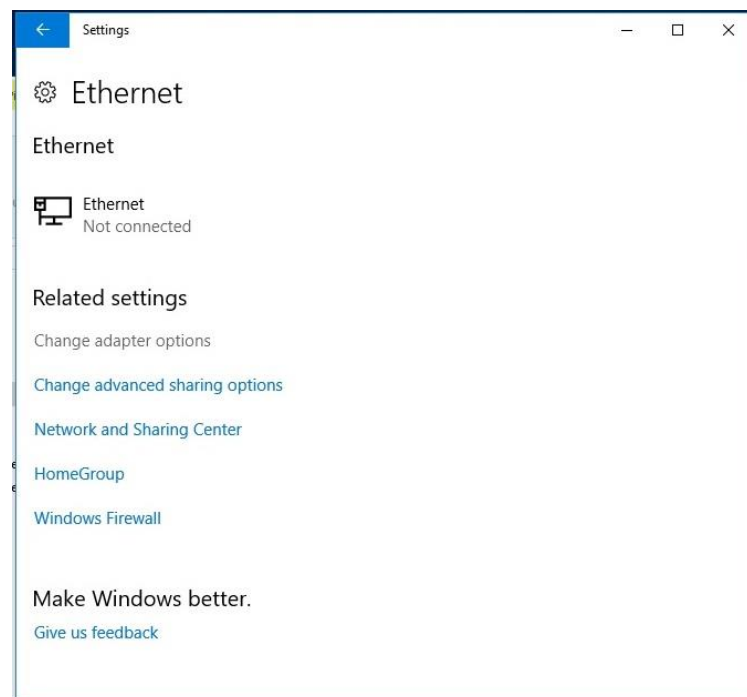
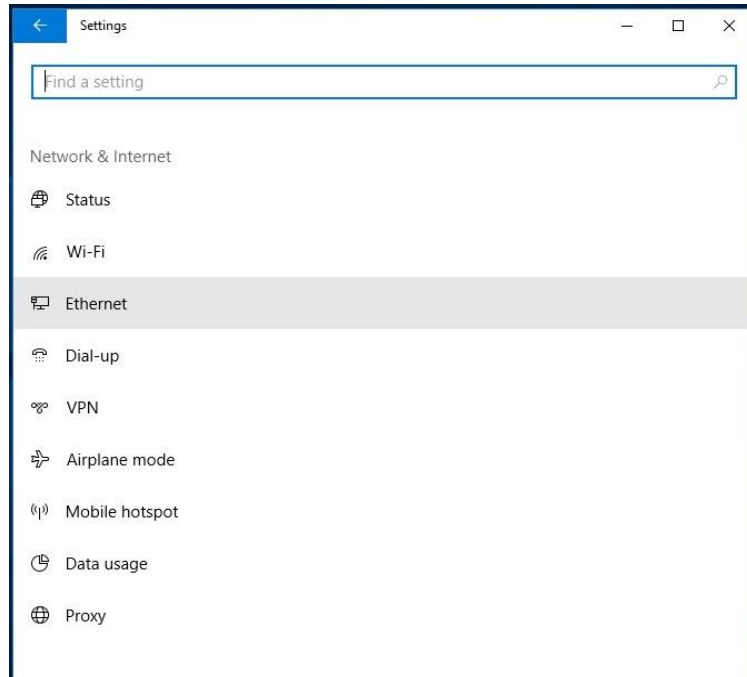

3. Right-click on Ethernet, and select Properties.

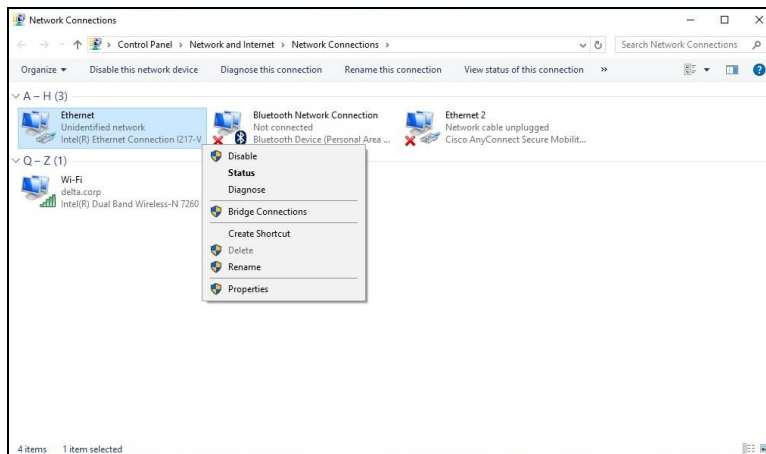

4. In the Properties window, select the Networking tab, and select Internet Protocol (TCP/IP).

5. Click Properties.

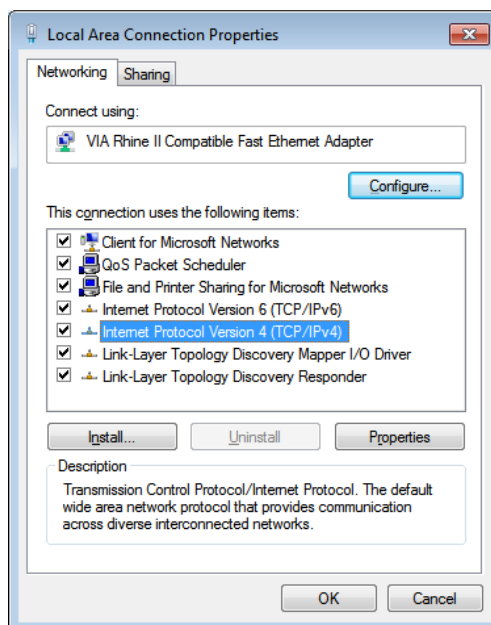

6. Click Use the following IP address and fill in the IP address and Subnet mask, then click OK.

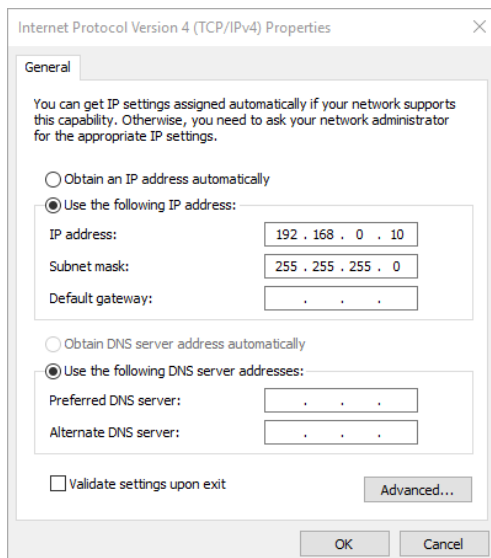

7. Press the Menu button on the projector.
8. Select Settings2 → Advanced1 → Network
9. After getting into Network, input the following:
  - ▶ DHCP: Off
  - ▶ IP Address: 192.168.0.10
  - ▶ Subnet Mask: 255.255.255.0
  - ▶ Gateway: 0.0.0.0
  - ▶ DNS Server: 0.0.0.0
10. Press **↵** (Enter) / **▶** to confirm settings.

Open a web browser

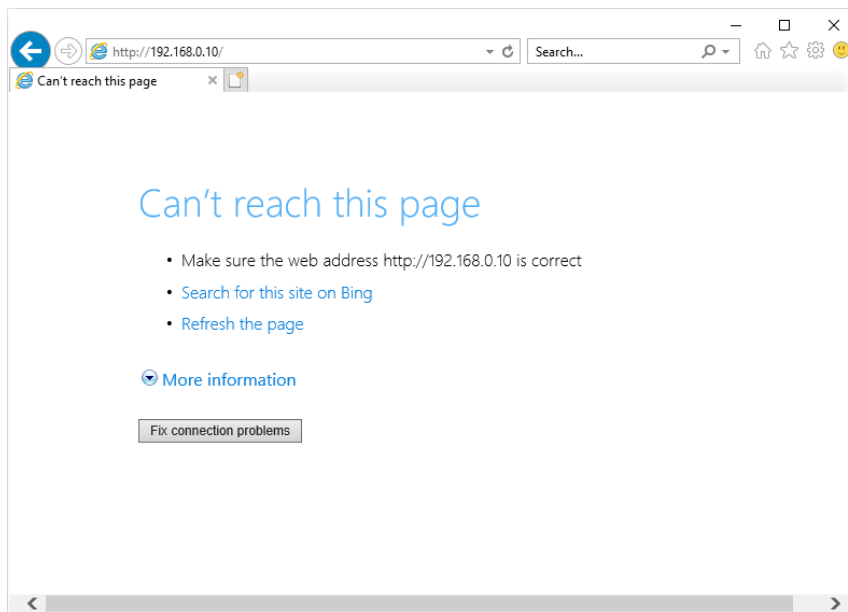

11. In the Address bar, input the IP address: 192.168.0.10.
12. Press **↵** (Enter) / **▶**.

The projector is setup for remote management. The LAN/RJ45 function displays as follows.

NEC	
<b>Projector Info</b>	
<b>PJLink Settings</b>	
<b>Crestron</b>	
<b>Model Name</b>	<b>P506QL</b>
<b>System</b>	
System Status	Power Off
Display Source	No Source
Lamp Hours	0
Display Mode	N/A
Error Status	No Error
<b>LAN Status</b>	
IP address	192.168.0.10
Subnet mask	255.255.255.0
Default gateway	192.168.0.1
DNS Server	0.0.0.0
MAC address	00:18:23:00:00:00
<b>Version</b>	
LAN Version	MHD10
F/W Version	V37



### 3 On-Screen Display (OSD) Menu Settings

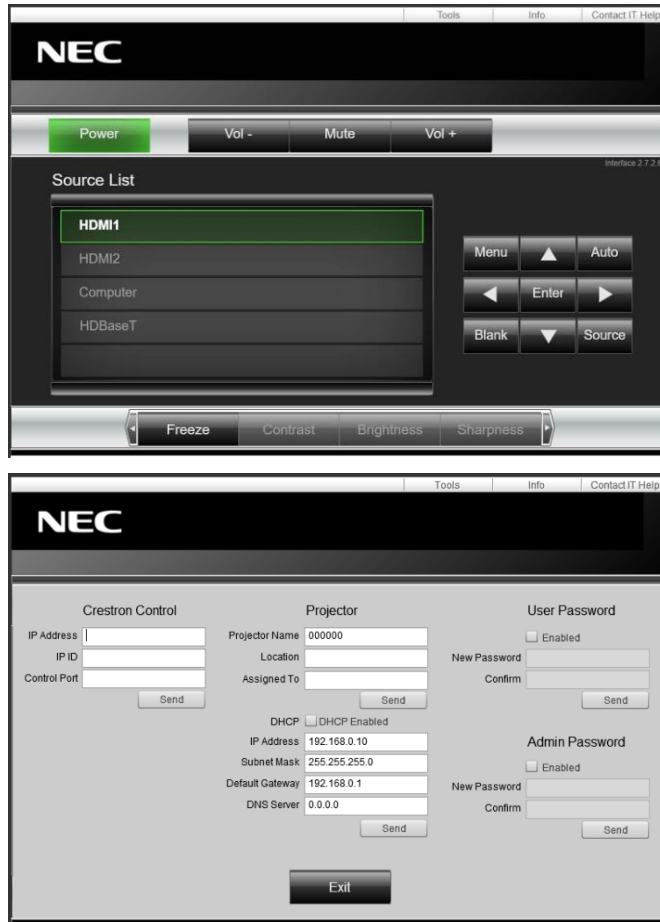

CATEGORY	ITEM	INPUT-LENGTH
Crestron Control	IP Address	15
	IP ID	3
	Port	5
Projector	Projector Name	10
	Location	10
	Assigned To	10
Network Configuration	DHCP (Enabled)	(N/A)
	IP Address	15
	Subnet Mask	15
	Default Gateway	15
	DNS Server	15
User Password	Enabled	(N/A)
	New Password	10
	Confirm	10
Admin Password	Enabled	(N/A)
	New Password	10
	Confirm	10

For more information, please visit <http://www.crestron.com>.

### 3-8 SETUP

Press the MENU button to open the OSD menu. Press the cursor ◀▶ button to move to the SETUP menu. Press the cursor ▲▼ button to move up and down in the SETUP menu. Press ◀▶ to enter and change values for settings.



ITEM	DESCRIPTION
LIGHT MODE	Press Enter to enter the Light mode menu. See page 40 for more information on <a href="#">LIGHT MODE</a> .
FAN MODE	Press the cursor ◀▶ button to enter and toggle between Normal and High fan speeds. Note: We recommend selecting high speed in high temperatures, high humidity, or high altitude (higher than 1500m/4921ft) areas.
REMOTE SENSOR	Press the cursor ◀▶ button to enter and select Remote Sensor.
STANDBY	Press Enter to enter the Standby menu. See page 41 for more information on <a href="#">STANDBY MODE</a> .
DIRECT POWER ON	Press the cursor ◀▶ button to enter and enable or disable automatic power On when AC power is supplied.
MENU	Press Enter to enter the MENU menu. See page 42 for more information on <a href="#">MENU</a> .
SECURITY	Press Enter to enter the Security menu. See page 43 for more information on <a href="#">SECURITY</a> .
LANGUAGE	Press the cursor ◀▶ button to enter and select a different localization Menu.
RESET ALL	Press Enter to reset all settings to default values (except Language).

#### LIGHT MODE

Press the MENU button to open the OSD menu. Press ◀▶ to move to the SETUP menu. Press ▲▼ to move to the LIGHT MODE menu and then press Enter or ▶. Press ▲▼ to move up and down in the LIGHT MODE menu.



ITEM	DESCRIPTION
ECO MODE	Press the cursor ◀▶ button to enter and adjust the ECO Mode.
ADJUST	Press the cursor ◀▶ button to enter and adjust the brightness level.
CONSTANT BRIGHTNESS	Press the cursor ◀▶ button to enter and enable or disable the Constant Brightness.

#### STANDBY MODE

Press the MENU button to open the OSD menu. Press ◀▶ to move to the SETUP menu. Press ▲▼ to move to the STANDBY MODE menu and then press Enter or ▶. Press ▲▼ to move up and down in the STANDBY MODE menu.



ITEM	DESCRIPTION
STANDBY MODE	Press the cursor ◀▶ button to select the standby mode. The options are NORMAL, NETWORK STANDBY and HDBaseT
AUTO POWER OFF	Press the cursor ◀▶ buttons to set the Auto Power Off timer. The projector automatically turns off if no input source is detected after the preset period of time.
OFF TIMER	Press the cursor ◀▶ button to enter and set Sleep timer. The projector automatically turns off after the preset period of time.

MENU

Press the MENU button to open the OSD menu. Press ◀▶ to move to the SETUP menu. Press ▲▼ to move to the MENU menu and then press Enter or ▶. Press ▲▼ to move up and down in the MENU menu.



ITEM	DESCRIPTION
MESSAGE DISPLAY	Press the cursor ◀▶ button to enter and enable or disable the Message Display.
MENU POSITION	Press the cursor ◀▶ button to enter and select Menu Position.
DISPLAY TIME	Press the cursor ◀▶ button to enter and select Display Time.
BACKGROUND	Press the cursor ◀▶ button to enter and select Background.

SECURITY

Press the MENU button to open the OSD menu. Press ◀▶ to move to the SETUP menu. Press ▲▼ to move to the SECURITY menu and then press Enter or ▶. Press ▲▼ to move up and down in the SECURITY menu.



ITEM	DESCRIPTION
CONTROL PANEL LOCK	Press the cursor ◀▶ button to enter and set Control Panel Lock.

### 3-9 INFO. Menu

Press the MENU button to open the OSD menu. Press the cursor ◀▶ button to move to the INFO. menu. Press the cursor ▲▼ button to move up and down in the INFO. menu.



ITEM	DESCRIPTION
INPUT TERMINAL	Display the activated source.
SOURCE NAME	Displays resolution/video information for RGB source and color standard for Video source.
LIGHT HOURS USED	Light hour used information is displayed.
IP ADDRESS	Showing IP Address.
VERSION	Showing system software version.
SERIAL NUMBER	Showing serial number of product.

## 4 Maintenance and Security

---

### 4 Maintenance and Security

#### 4-1 Cleaning the Projector

Cleaning the projector to remove dust and grime will help ensure trouble-free operation.



**Warning:**

1. Be sure to turn off and unplug the projector at least 30 minutes before cleaning. Failure to do so could result in a severe burn.
2. Use only a dampened cloth when cleaning. Do not allow water to enter the ventilation openings on the projector.
3. If a little water gets into the projector interior while cleaning, leave unplugged in a well-ventilated room for several hours before using.
4. If a lot of water gets into the projector interior when cleaning, have the projector serviced.

#### Cleaning the Lens

You can purchase optic lens cleaner from most camera stores. Refer to the following to clean the projector lens. Remove the lens cap before wiping the lens.

1. Apply a little optic lens cleaner to a clean soft cloth. (Do not apply the cleaner directly to the lens.)
2. Lightly wipe the lens in a circular motion.



**Caution:**

1. Do not use abrasive cleaners or solvents.
2. To prevent discoloration or fading, avoid getting cleaner on the projector case.

#### Cleaning the Case

Refer to the following to clean the projector case.

1. Wipe off dust with a clean dampened cloth.
2. Moisten the cloth with warm water and mild detergent (such as used to wash dishes), and then wipe the case.
3. Rinse all detergent from the cloth and wipe the projector again.



**Caution:**

To prevent discoloration or fading of the case, do not use abrasive alcohol-based cleaners.



## 4-2 Using the Physical Lock

### Using the Security Slot

If you are concerned about security, attach the projector to a permanent object with the security slot and a security cable.

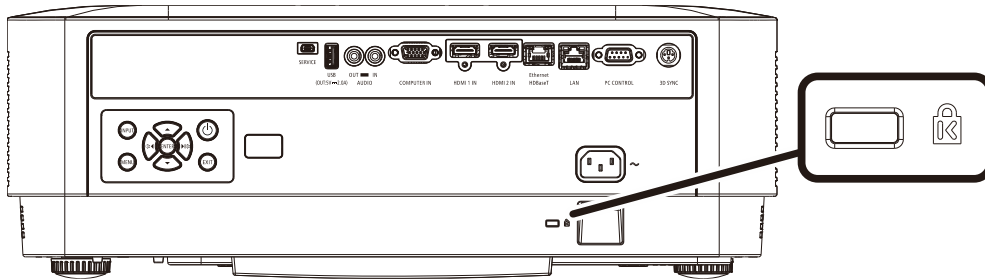

*Note:*

Contact your vendor for details on purchasing a suitable Kensington security cable.

The security lock corresponds to Kensington's MicroSaver Security System. If you have any comment, contact: Kensington, 2853 Campus Drive, San Mateo, CA 94403, U.S.A. Tel: 800-535-4242, <http://www.Kensington.com>.

### Using the Security Bar Lock

In addition to the password protection function and the Kensington lock, the Security Bar Opening helps protect the projector from unauthorized use.

See the following picture.

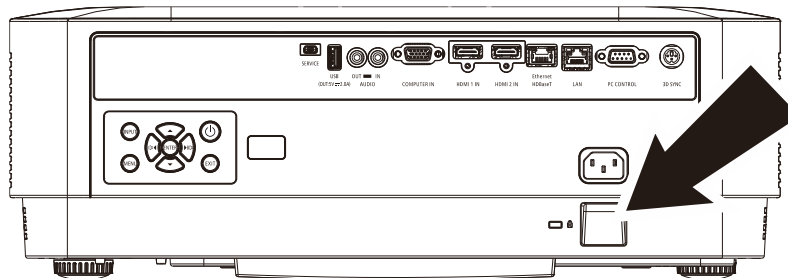

## 5 Troubleshooting

---

### 5 Troubleshooting

#### 5-1 Common Problems and Solutions

These guidelines provide tips to deal with problems you may encounter while using the projector. If the problem remains unsolved, contact your dealer for assistance.

Often after time spent troubleshooting, the problem is traced to something as simple as a loose connection. Check the following before proceeding to the problem-specific solutions.

- *Use some other electrical device to confirm that the electrical outlet is working.*
- *Ensure the projector is turned on.*
- *Ensure all connections are securely attached.*
- *Ensure the attached device is turned on.*
- *Ensure a connected PC is not in suspending mode.*
- *Ensure a connected notebook computer is configured for an external display.  
(This is usually done by pressing an Fn-key combination on the notebook.)*

#### 5-2 Tips for Troubleshooting

In each problem-specific section, try the steps in the order suggested. This may help you to solve the problem more quickly.

Try to pin point the problem and thus avoid replacing non-defective parts.

For example, if you replace batteries and the problem remains, put the original batteries back and go to the next step.

Keep a record of the steps you take when troubleshooting: The information may be useful when calling for technical support or for passing on to service personnel.

## 5-3 LED Error Messages

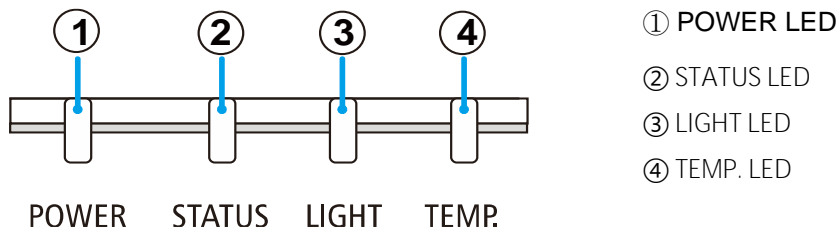

Error over view	POWER	STATUS	LIGHT	TEMP.
temperature failure (thermistor)	Red (Blink)			
top cover cover failure	Red (Blink)	Red (Light)	Green (Light)	
Fan failure	Red (Light)	Orange (Light)		
LD Bank/Driver error	Red (Light)	Orange (Light)	Orange (Light)	
Slave CPU communication error	Red (Light)	Orange (Light)	Orange (Light)	
PW/CW spin failed (Include laser driver BD)	Red (Light)	Red (Light)	Orange (Light)	

## 5-4 Image Problems

*Problem: No image appears on the screen*

1. Verify the settings on your notebook or desktop PC.
2. Turn off all equipment and power up again in the correct order.

*Problem: The image is blurred*

1. Adjust the Focus on the projector.
2. Press the Auto button on the remote control or projector.
3. Ensure the projector-to-screen distance is within the specified range.
4. Check that the projector lens is clean.

*Problem: The image is wider at the top or bottom (trapezoid effect)*

1. Position the projector so it is as perpendicular to the screen as possible.
2. Use the Keystone button on the remote control or projector to correct the problem.

*Problem: The image is reversed*

Check the ORIENTATION setting on the DISPLAY menu of the OSD.

*Problem: The image is streaked*

To ensure the problem is not caused by a connected PC's video card, connect to another computer

*Problem: The image is flat with no contrast*

Adjust the CONTRAST setting on the ADJUST menu of the OSD.

*Problem: The color of the projected image does not match the source image.*

Adjust the COLOR TEMPERATURE and GAMMA settings on the ADJUST -> DETAIL SETTINGS menu of the OSD.

### 5-5 Light Source Problems

*Problem: There is no light from the projector*

1. Check that the power cable is securely connected.
2. Ensure the power source is good by testing with another electrical device.
3. Restart the projector in the correct order and check that the Power LED is on.

### 5-6 Remote Control Problems

*Problem: The projector does not respond to the remote control*

1. Direct the remote control towards remote sensor on the projector.
2. Ensure the path between remote and sensor is not obstructed.
3. Turn off any fluorescent lights in the room.
4. Check the battery polarity.
5. Replace the batteries.
6. Turn off other Infrared-enabled devices in the vicinity.
7. Have the remote control serviced.

### 5-7 Audio Problems

*Problem: There is no sound*

1. Adjust the volume on the remote control.
2. Adjust the volume of the audio source.
3. Check the audio cable connection.
4. Test the source audio output with other speakers.
5. Have the projector serviced.

*Problem: The sound is distorted*

1. Check the audio cable connection.
2. Test the source audio output with other speakers.
3. Have the projector serviced.

### 5-8 Having the Projector Serviced

If you are unable to solve the problem, you should have the projector serviced. Pack the projector in the original carton. Include a description of the problem and a checklist of the steps you took when trying to fix the problem: The information may be useful to service personnel. For servicing, return the projector to the place you purchased it.

## 5-9 HDMI Q & A

### **Q. What is the difference between a “Standard” HDMI cable and a “High-Speed” HDMI cable?**

Recently, HDMI Licensing Administrator, Inc. announced that cables would be tested as Standard or High-Speed cables.

• **Standard (or “category 1”)** HDMI cables have been tested to perform at speeds of 75Mhz or up to 2.25Gbps, which is the equivalent of a 720p/1080i signal.

• **High Speed (or “category 2”)** HDMI cables have been tested to perform at speeds of 340Mhz or up to 10.2Gbps, which is the highest bandwidth currently available over an HDMI cable and can successfully handle 1080p signals including those at increased color depths and/or increased refresh rates from the Source. High-Speed cables are also able to accommodate higher resolution displays, such as WQXGA cinema monitors (resolution of 2560 x 1600).

### *Q. How do I run HDMI cables longer than 10 meters?*

There are many HDMI Adapters working on HDMI solutions that extend a cable’s effective distance from the typical 10 meter range to much longer lengths. These companies manufacture a variety of solutions that include active cables (active electronics built into cables that boost and extend the cable’s signal), repeaters, amplifiers as well as CAT5/6 and fiber solutions.

### *Q. How can I tell if a cable is an HDMI certified cable?*

All HDMI products are required to be certified by the manufacturer as part of the HDMI Compliance Test Specification. However, there may be instances where cables bearing the HDMI logo are available but have not been properly tested. HDMI Licensing Administrator, Inc. actively investigates these instances to ensure that the HDMI trademark is properly used in the market. We recommend that consumers buy their cables from a reputable source and a company that is trusted.

For more detail information check <http://www.hdmi.org/learningcenter/faq.aspx#49>

## 6 Specifications

### 6 Specifications

#### 6-1 Specifications

Model Name	NP-P506QL	
Display Type	0.47" (11.9mm) TRP	
Resolution	1080p, 4K UHD w/ pixel shift	
Throw Ratio	1.127(Wide) ~1.697(Tele)	
Zoom Ratio	1.5X	
Contrast ratio(all white/all black)	500,000:1 with dynamic contrast	
F-number / focal length	1.8(Wide) ~ 2.43(Tele) / 12.1 ~18.1 mm	
Lens Shift	H: +/-0.2 V: +/-0.6	
Image size (diagonal)	50" (1270mm) (Tele) to 310" (7874mm) (Wide) inches	
Projection distance	1.6m (63") ~ 8m (315")	
Keystone Correction	Vertical	+/- 30 steps
Projection Methods	Front, Rear, Desktop/Ceiling (Rear, Front)	
Data Compatibility	VGA, SVGA, XGA, SXGA, SXGA+, UXGA, WUXGA, UHD@60hz, Mac	
SDTV/EDTV/HDTV	480i, 576i, 480p, 576p, 720p, 1080i, 1080p, UHD	
H-Sync	15.31 – 102kHz	
V-Sync	24 - 30Hz, 47 – 120 Hz	
Environmental Operation Condition	0° ~ 40°C , 10~85%(No condensing)	
Environmental Storage Condition	-20° ~ 60°C, 5% to 95% (No condensation)	
Dimensions	480mm (L) x 400mm (W) x 172mm (H)	
Weight	11.5 kg	
Light Output	5000lm(Normal)	
AC Input	AC Universal 100 – 240, Typical @ 110VAC (100 – 240)/+-10%	
Power Consumption	580W (Normal), 330W (Eco) , <0.5W (Standby), <2W (Network Standby), <6.5W (HDBaseT Standby)	
Light Source: Laser-Phosphor	Laser Diode	
Audio Speaker	10W x 1	
Input Terminals	VGA in x 1	
	Mini-jack Stereo x 1	
	HDMI 2.0 x 2	
	HDBaseT x 1	

Output Terminals	Audio out x 1
	USB Type A for 5V/2A power support
	3D-Sync x 1
Control Terminals	PC Control(RS-232) x 1
	RJ-45 x 1 (10/100Mbps)
	USB mini B for service x 1
Security	Security Slot
	Security Bar

*Note:*

- *For questions regarding product specifications, please contact your local distributor.*

For additional information visit:

US: <https://www.necdisplay.com/>

Europe: <https://www.nec-display-solutions.com/>

Global: <https://www.nec-display.com/global/index.html>

For information on our optional accessories, visit our website or see our brochure.

The specifications are subject to change without notice.

## 6-2 Projection Distance vs. Projection Size

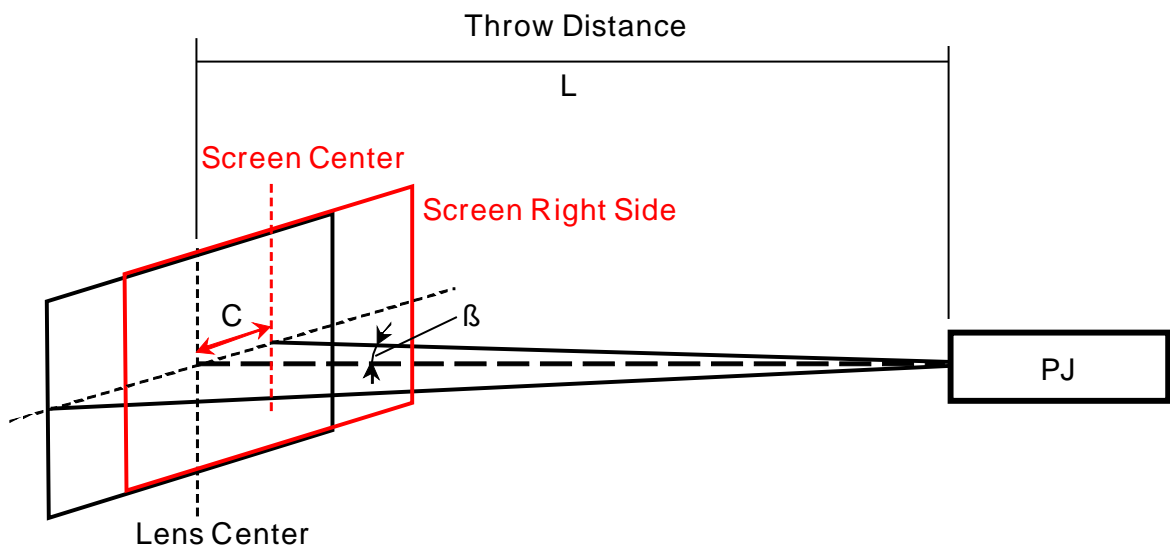
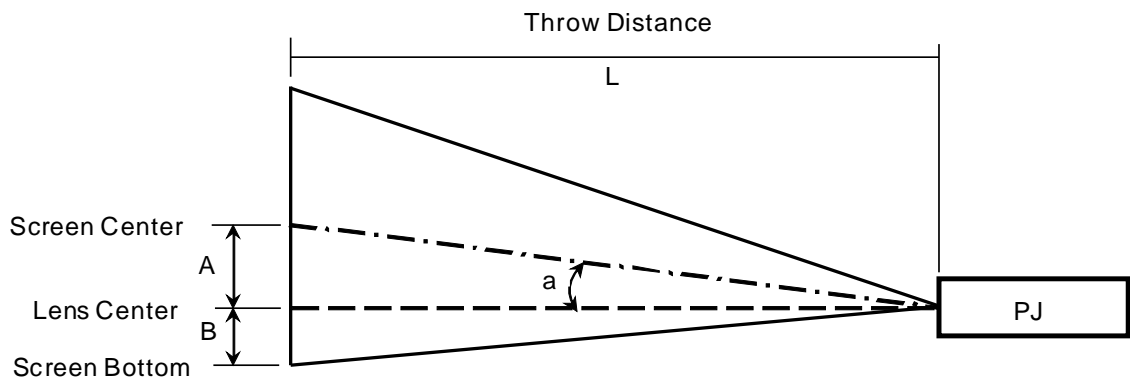

A=Vertical distance between lens center and screen center

B=Vertical distance between lens center and bottom of screen (top of screen for ceiling application)

L=Throw distance

$\alpha$ =Throw angle

NOTE: Distance may vary +/-5%



Projection Distance and Size Table

Screen Size						Throw Distance				V Shift										Throw Ratio			
						L				A		B				$\alpha$							
Diagonal(S)		Width		Height		wide		tele		Lens Shift MAX		Lens Shift MIN		Lens Shift MAX		Lens Shift MIN		Lens Shift MAX		Lens Shift MIN		wide	tele
										inch	mm	inch	mm	inch	mm	inch	mm	inch	mm	inch	mm		
50	1270	44	1107	25	623	48.3	1227	73.1	1857	14.7	374	-14.7	-374	2.5	62	-27.0	-685	16.9	11.4	-16.9	-11.4	1.11	1.68
60	1524	52	1328	29	747	58.3	1480	88.0	2236	17.6	448	-17.6	-448	2.9	75	-32.4	-822	16.9	11.3	-16.9	-11.3	1.11	1.68
70	1778	61	1550	34	872	68.2	1733	102.9	2615	20.6	523	-20.6	-523	3.4	87	-37.8	-959	16.8	11.3	-16.8	-11.3	1.12	1.69
80	2032	70	1771	39	996	78.2	1986	117.9	2994	23.5	598	-23.5	-598	3.9	100	-43.1	-1096	16.8	11.3	-16.8	-11.3	1.12	1.69
90	2286	78	1992	44	1121	88.2	2239	132.8	3373	26.5	672	-26.5	-672	4.4	112	-48.5	-1233	16.7	11.3	-16.7	-11.3	1.12	1.69
100	2540	87	2214	49	1245	98.1	2492	147.7	3752	29.4	747	-29.4	-747	4.9	125	-53.9	-1370	16.7	11.3	-16.7	-11.3	1.13	1.69
120	3048	105	2657	59	1494	118.1	2999	177.6	4510	35.3	897	-35.3	-897	5.9	149	-64.7	-1644	16.6	11.2	-16.6	-11.2	1.13	1.70
150	3810	131	3321	74	1868	148.0	3758	222.3	5647	44.1	1121	-44.1	-1121	7.4	187	-80.9	-2055	16.6	11.2	-16.6	-11.2	1.13	1.70
180	4572	157	3985	88	2241	177.9	4517	267.1	6784	52.9	1345	-52.9	-1345	8.8	224	-97.1	-2466	16.6	11.2	-16.6	-11.2	1.13	1.70
200	5080	174	4428	98	2491	197.8	5024	296.9	7542	58.8	1494	-58.8	-1494	9.8	249	-107.9	-2740	16.6	11.2	-16.6	-11.2	1.13	1.70
240	6096	209	5313	118	2989	237.6	6036	356.6	9058	70.6	1793	-70.6	-1793	11.8	299	-129.4	-3287	16.5	11.2	-16.5	-11.2	1.14	1.70
270	6858	235	5977	132	3362	267.5	6796	401.4	10195	79.4	2017	-79.4	-2017	13.2	336	-145.6	-3698	16.5	11.2	-16.5	-11.2	1.14	1.71
310	7874	270	6863	152	3860	307.4	7808	461.0	11711	91.2	2316	-91.2	-2316	15.2	386	-167.2	-4246	16.5	11.2	-16.5	-11.2	1.14	1.71
100	2540	87	2214	49	1245	98.1	2492	147.7	3752	29.4	747	-29.4	-747	4.9	125	-53.9	-1370	16.7	11.3	-16.7	-11.3	1.13	1.69

※When screen bottom is lower than lens center, B's value is negative.

Screen Size						Throw Distance				H Shift							
						L				C		$\beta$					
Diagonal		Width		Height		wide		tele		Lens Shift MAX(Right)		Lens Shift MIN(Left)		Lens Shift MAX(Right)		Lens Shift MIN(Left)	
										inch	mm	inch	mm	inch	mm	inch	mm
50	1270	44	1107	25	623	48.3	1227	73.1	1857	8.7	221	-8.7	-221	10.2	6.8	-10.2	-6.8
60	1524	52	1328	29	747	58.3	1480	88.0	2236	10.5	266	-10.5	-266	10.2	6.8	-10.2	-6.8
70	1778	61	1550	34	872	68.2	1733	102.9	2615	12.2	310	-12.2	-310	10.1	6.8	-10.1	-6.8
80	2032	70	1771	39	996	78.2	1986	117.9	2994	13.9	354	-13.9	-354	10.1	6.7	-10.1	-6.7
90	2286	78	1992	44	1121	88.2	2239	132.8	3373	15.7	398	-15.7	-398	10.1	6.7	-10.1	-6.7
100	2540	87	2214	49	1245	98.1	2492	147.7	3752	17.4	443	-17.4	-443	10.1	6.7	-10.1	-6.7
120	3048	105	2657	59	1494	118.1	2999	177.6	4510	20.9	531	-20.9	-531	10.0	6.7	-10.0	-6.7
150	3810	131	3321	74	1868	148.0	3758	222.3	5647	26.1	664	-26.1	-664	10.0	6.7	-10.0	-6.7
180	4572	157	3985	88	2241	177.9	4517	267.1	6784	31.4	797	-31.4	-797	10.0	6.7	-10.0	-6.7
200	5080	174	4428	98	2491	197.8	5024	296.9	7542	34.9	886	-34.9	-886	10.0	6.7	-10.0	-6.7
240	6096	209	5313	118	2989	237.6	6036	356.6	9058	41.8	1063	-41.8	-1063	10.0	6.7	-10.0	-6.7
270	6858	235	5977	132	3362	267.5	6796	401.4	10195	47.1	1195	-47.1	-1195	10.0	6.7	-10.0	-6.7
310	7874	270	6863	152	3860	307.4	7808	461.0	11711	54.0	1373	-54.0	-1373	10.0	6.7	-10.0	-6.7
100	2540	87	2214	49	1245	98.1	2492	147.7	3752	17.4	443	-17.4	-443	10.1	6.7	-10.1	-6.7

## 6-3 Timing Mode Table

## Table of Supported Frequency

The unit automatically determines PC signals to select the appropriate resolution. Some signals may require manual adjustment.

## VGA

Signal	Resolution	Aspect Ratio	Refresh Rate
VGA	640 x 480	4:3	60
SVGA	800 x 600	4:3	60
XGA	1024 x 768	4:3	60
WXGA	1280 x 768	15:9	60
WXGA	1360 x 768	16:9 *3	60
Quad-VGA	1280 x 960	4:3	60
SXGA	1280 x 1024	5:4	60
SXGA+	1400 x 1050	4:3	60
WXGA+	1440 x 900	16:10	60
UXGA	1600 x 1200	4:3	60
WSXGA+	1680 x 1050	16:10	60
HD	1280 x 720	16:9	60
Full HD	1920 x 1080	16:9	60

## HDMI

Signal	Resolution	Aspect Ratio	Refresh Rate
VGA	640 x 480	4:3	59.94/60/72/75
VGA	720 x 400	9:5	70
SDTV (480p)	720 x 480	4:3/16:9	59.94
SDTV (480i)	720 x 480	4:3/16:9	59.94
SDTV (576i)	720 x 576	4:3/16:9	50
SDTV (576p)	720 x 576	4:3/16:9	50
SVGA	800 x 600	4:3	60/72/75
XGA	1024 x 768	4:3	60/70/75
HDTV (720p)	1280 x 720	16:9	50/59.94/60
WXGA	1280 x 768	5:3	60
Quad-VGA	1280 x 960	4:3	60
SXGA	1280 x 1024	5:4	60
WXGA	1360 x 768	16:9	60
SXGA+	1400 x 1050	4:3	60
WXGA+	1440 x 900	16:10	60
UXGA	1600 x 1200	4:3	60
WSXGA+	1680 x 1050	16:10	60
HDTV(1080i)	1920 x 1080	16:9	50/59.94
HDTV (1080p)	1920 x 1080	16:9	23.94/25/29.97/50/59.94/60
WUXGA	1920 x 1200	16:10	60
4K UHD	3840 x 2160	16:9	23.98/25/29.97/50/59.94
4K2K	4096 x 2160	17:9	23.94/25/29.97/50/59.94

## HDBaseT

Signal	Resolution	Aspect Ratio	Refresh Rate
VGA	640 x 480	4:3	59.94/60/72/75
VGA	720 x 400	9:5	70
SDTV (480p)	720 x 480	4:3/16:9	59.94
SDTV (480i)	720 x 480	4:3/16:9	59.94
SDTV (576i)	720 x 576	4:3/16:9	50
SDTV (576p)	720 x 576	4:3/16:9	50
SVGA	800 x 600	4:3	60/72/75
XGA	1024 x 768	4:3	60/70/75
HDTV (720p)	1280 x 720	16:9	50/59.94/60
WXGA	1280 x 768	5:3	60
Quad-VGA	1280 x 960	4:3	60
SXGA	1280 x 1024	5:4	60
WXGA	1360 x 768	16:9	60
SXGA+	1400 x 1050	4:3	60
WXGA+	1440 x 900	16:10	60
UXGA	1600 x 1200	4:3	60
WSXGA+	1680 x 1050	16:10	60
HDTV(1080i)	1920 x 1080	16:9	50/59.94
HDTV (1080p)	1920 x 1080	16:9	23.94/25/29.97/50/59.94/60
WUXGA	1920 x 1200	16:10	60
4K UHD	3840 x 2160	16:9	23.98/25/29.97/50/59.94

## Table of Supported Frequency For 3D mode

The unit automatically determines PC signals to select the appropriate resolution. Some signals may require manual adjustment.

## True 3D Video Compatibility table

Input Resolutions	HDMI 1.4a 3D Input	Input timing	
		1280 X 720P @ 50Hz	Top - and - Bottom
		1280 X 720P @ 60Hz	Top - and - Bottom
		1280 X 720P @ 50Hz	Frame packing
		1280 X 720P @ 60Hz	Frame packing
		1920 X 1080i @50 Hz	Side- by-Side (Half)
		1920 X 1080i @60 Hz	Side- by-Side (Half)
		1920 X 1080P @24 Hz	Top - and – Bottom
		1920 X 1080P @24 Hz	Frame packing

*Note:*  
3D glasses must be supported to 144Hz.

6-4 Projector Dimensions

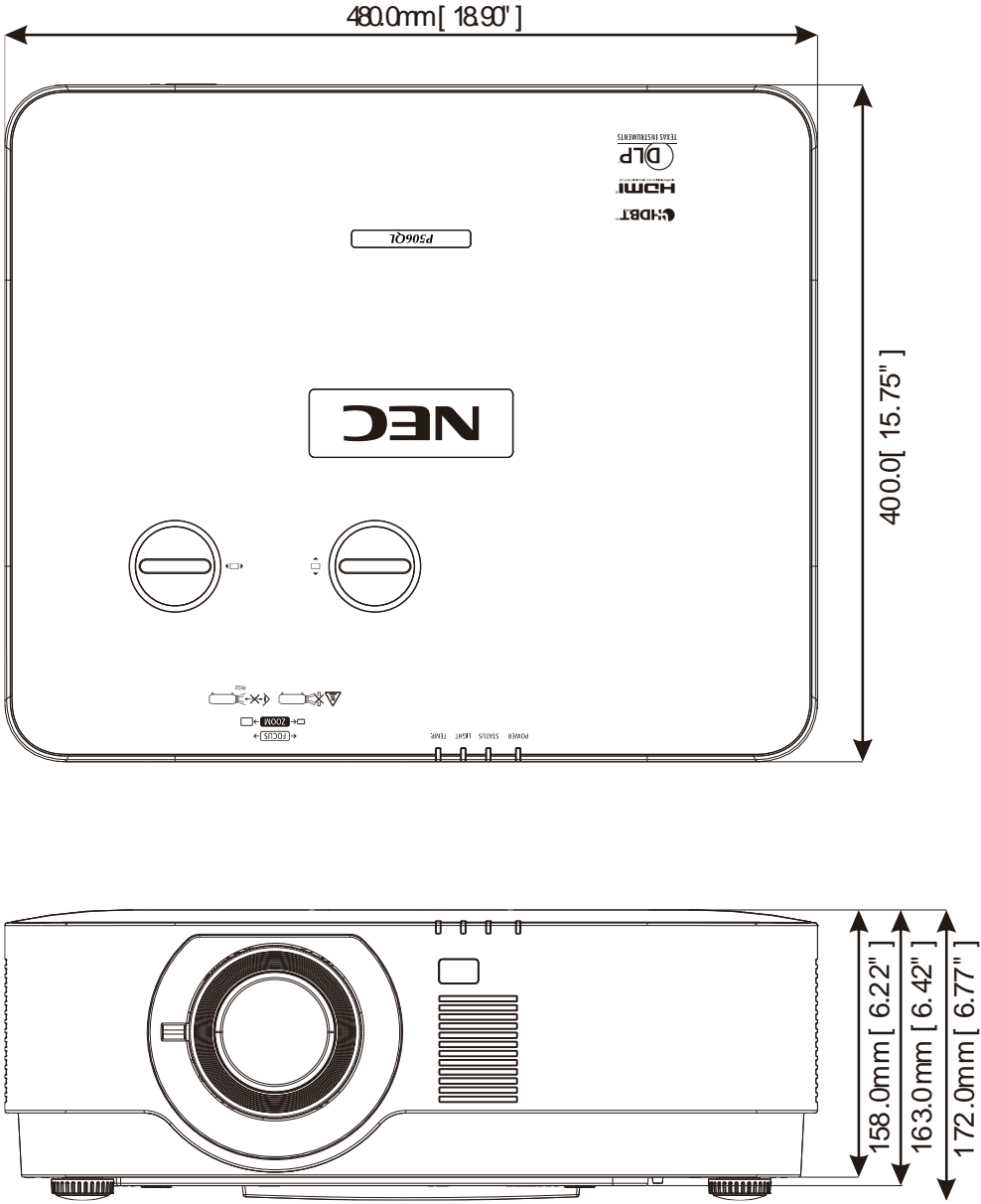

## 7 Appendix I

### 7 Appendix I

#### 7-1 RS-232C Protocol

##### RS232 Setting

Baud rate	9600 bps
Data length	8 bit
Parity	No parity
Stop bit	One bit
X on/off	None
Communications procedure	Full duplex

##### PC Control Code

Function	Code Data
POWER ON	02H 00H 00H 00H 00H 02H
POWER OFF	02H 00H 00H 00H 00H 03H
INPUT SELECT COMPUTER	02H 03H 00H 00H 02H 01H 01H 09H
INPUT SELECT HDMI1	02H 03H 00H 00H 02H 01H A1H A9H
INPUT SELECT HDMI2	02H 03H 00H 00H 02H 01H A2H AAH
INPUT SELECT HDBaseT	02H 03H 00H 00H 02H 01H BFH C7H
PICTURE MUTE ON	02H 10H 00H 00H 00H 12H
PICTURE MUTE OFF	02H 11H 00H 00H 00H 13H

NOTE: Contact your local dealer for a full list of the PC Control Codes if needed.

## REGISTER YOUR PROJECTOR! (for residents in the United States, Canada, and Mexico)

Please take time to register your new projector. This will activate your limited parts and labor warranty and InstaCare service program.

Visit our web site at [www.necdisplay.com](http://www.necdisplay.com), click on support center/register product and submit your completed form online.

Upon receipt, we will send a confirmation letter with all the details you will need to take advantage of fast, reliable warranty and service programs from the industry leader, NEC Display Solutions of America, Inc.

**NEC**